

6.0-16.0V

Input

0.75-5.0V

Outputs

10A

Current

Non

Isolated

SIP

Single Inline Pins

The NiQor SMT DC/DC converter is a non-isolated buck regulator, which employs synchronous rectification to achieve extremely high conversion efficiency. The NiQor family of converters are used predominately in DPA systems using a front end DC/DC high power brick (48Vin to low voltage bus). The non-isolated NiQor converters are then used at the point of load to create the low voltage outputs required by the design. The wide trim module can be programmed to a variety of output voltages through the use of a single external resistor. RoHS compliant (see page 13).

NiQor

Non-Isolated



NiQor wide trim module

Operational Features

- Ultra high efficiency, up to 95% at full rated load
- Delivers up to 10 Amps of output current with minimal derating - no heatsink required
- Input Voltage Range : 6.0 - 16.0V
- Fast transient response time
- On-board input and output filter capacitor
- No minimum load requirement means no preload resistors required

Mechanical Features

- DOSA standard pin-out configuration
- Industry standard size: 2" x 0.5" x 0.288" (50.8 x 12.7 x 7.32 mm)
- Total weight: 0.3 oz. (9.4 grams), lower mass greatly reduces vibration and shock problems
- Open frame construction maximizes air flow cooling
- Also available in SMT packaging

Control Features

- On/Off control
- Output voltage trim (industry standard) permits custom voltages and voltage margining
- Remote Sense (standard option)

DOSA

Distributed-power
Open Standards Alliance

Protection Features

- Input under-voltage lockout disables converter at low input voltage conditions
- Temperature compensated over-current shutdown protects converter from excessive load current or short circuits
- Output over-voltage protection protects load from damaging voltages
- Thermal shutdown protects converter from abnormal environmental conditions

Safety Features

- UL 60950-1:2007
- CAN/CSA-C22.2 No. 60950-1-07
- EN60950-1/A1:2010
- RoHS compliant (see page 13)

MECHANICAL DIAGRAM

Vertical Mount

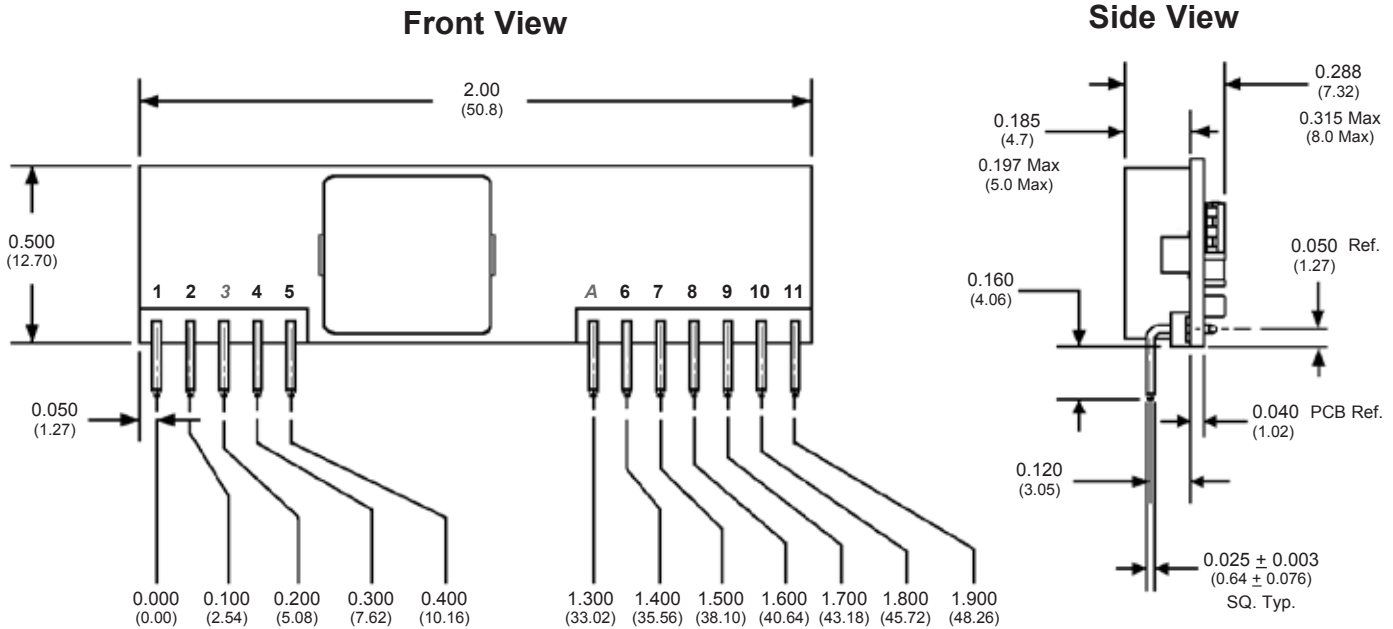

NOTES

- 1) All pins are 0.025" (0.64mm) ±0.003 (0.076mm) square.
- 2) All Pins: Material - Copper Alloy
Finish - Tin over Nickel plate
- 3) Vertical, horizontal, vertical with reverse pins and surface mount options (future) available.
- 4) Undimensioned components are shown for visual reference only.
- 6) All dimensions in inches (mm)
Tolerances: x.xx ±0.02 in. (x.x ±0.5mm)
x.xxx ±0.010 in. (x.xx ±0.25mm)
- 7) Weight: 0.30 oz. (9.4 g) typical
- 8) Workmanship: Meets or exceeds IPC-A-610C Class II

Pin Connection Notes:

1. Pin 10 - for fixed resistors, connect between Trim and Common (Ground).
2. Pin 11 - see section on Remote ON/OFF pin for description of enable logic options.

PIN DESIGNATIONS

Pin No.	Name	Function
1	Vout(+)	Positive output voltage
2	Vout(+)	Positive output voltage
3	SENSE(+)	<i>Positive remote sense</i>
4	Vout(+)	Positive output voltage
5	Common	
A	N/C	<i>No Connection</i>
6	Common	
7	Vin(+)	Positive input voltage
8	Vin(+)	Positive input voltage
9	N/C	<i>No Connection</i>
10	TRIM ¹	Output voltage trim (trim-up only)
11	ON/OFF ²	LOGIC input to turn the converter on and off.

Pins in Italics Shaded text are Optional



Technical Specification

Input: 6.0 - 16.0V
Outputs: 0.75 - 5.0V
Current: 10A
Package: SIP

MECHANICAL DIAGRAM

Horizontal Mount

Front View

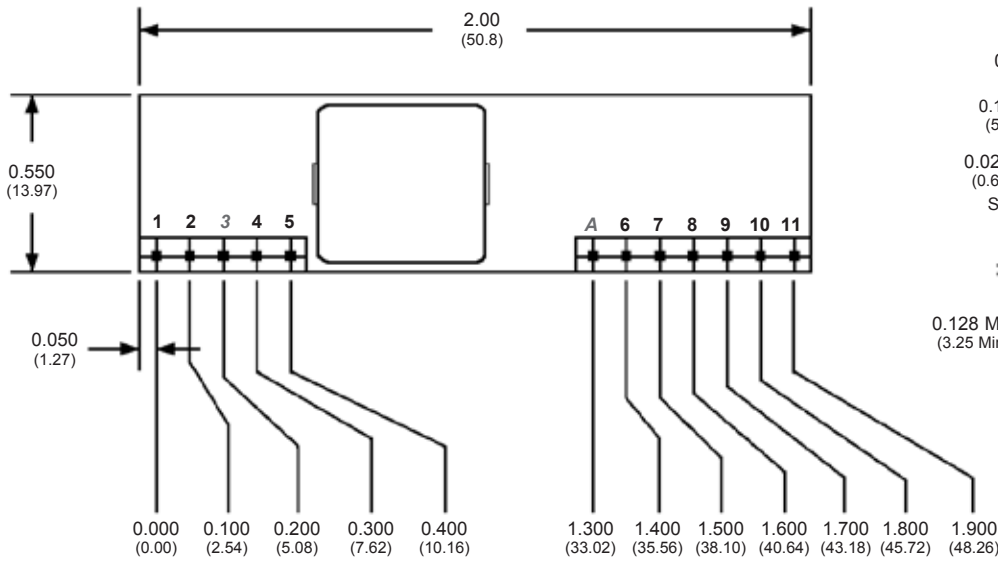

Side View

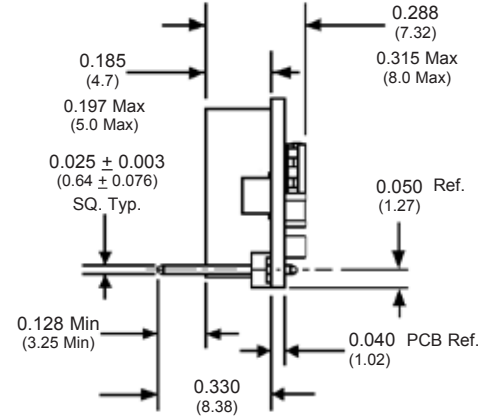

See previous page for notes and pin designations.

ELECTRICAL CHARACTERISTICS - NQ16W50xKA10 Series

T_A=25°C, airflow rate=300 LFM, V_{in}=12Vdc unless otherwise noted; full operating temperature range is -40°C to +105°C ambient temperature with appropriate power derating. Specifications subject to change without notice.

Parameter	Module	Min.	Typ.	Max.	Units	Notes & Conditions
ABSOLUTE MAXIMUM RATINGS						
Input Voltage						
Non-Operating	All	0		18	V	Continuous
Operating	All			16	V	Continuous
Operating Temperature	All	-40		105	°C	
Storage Temperature	All	-55		125	°C	
Voltage at ON/OFF input pin	All	-3		15	V	
RECOMMENDED OPERATING CONDITIONS						
Input Voltage Range	All	6		16	V	
Input Fuse Rating	All			20	A	Fast blow external fuse recommended
External Input Capacitance	All	100			µF	ESR<1.5Ω
Output Voltage	All	0.75		5.5	V	
Output Current	All	0		10	A	
INPUT CHARACTERISTICS						
Input Under-Voltage Lockout						
Turn-On Voltage Threshold	All	5.35	5.73	6.10	V	
Turn-Off Voltage Threshold	All	4.50	4.73	4.95	V	
Lockout Hysteresis	All		1		V	
Maximum Input Current	0.75V			1.6	A	6Vin, 100% load
"	2.5V			4.5	A	"
"	5.0V			8.6	A	"
No-Load Input Current	0.75V		31		mA	12Vin
"	2.5V		71		mA	"
"	5.0V		132		mA	"
Disabled Input Current	All		3		mA	
Inrush Current Transient Rating	All			0.1	A ² s	With min. output capacitance
Input Filter Capacitor Value	All		30		µF	
Input Reflected-Ripple Current	0.75V		36		mA	12Vin, 100% load, pk-pk value
"	2.5V		68		mA	"
"	5.0V		98		mA	"
OUTPUT CHARACTERISTICS						
Output Voltage Set Point	0.75V	0.745	0.75	0.755	V	12Vin 50% load
Output Voltage Range	All	0.75		5.0	V	Set output by Rtrim-up
Operating Output Current Range	All	0		10	A	
Output Voltage Regulation						
Over Line	All			0.5	%	With sense pin
Over Load	All			0.5	%	"
Over Temperature	All			1	%	"
Total Output Voltage Range	All			3	%	With sense pin, over sample, line, load, temp. & life
Output Voltage Ripple and Noise (pk-pk\RMS)	1.0V		35\9.0		mV	Full load; 20MHz bandwidth
"	2.5V		55\15.0		mV	"
"	5.0V		87\25.0		mV	"
Output DC Over Current Shutdown	All	12	19	24	A	
External Output Capacitance	All	0		5000	µF	>0.5mΩ
DYNAMIC CHARACTERISTICS						
Input Voltage Ripple Rejection	All		50		dB	120Hz
Output Voltage during Current Transient						
For a Step Change in Output Current (0.1A/µs)	All		180		mV	50%-75%-50% Iout max; 100µF
For a Step Change in Output Current (3A/µs)	All		180		mV	50%-75%-50% Iout max; 470µF
Settling Time	All		100		µs	To within 1.5% Vout nom.
Turn on Transient						
Inhibit Time	All	2		4	ms	Resistive load
Rise Time	All	2		6	ms	"
Output Voltage Overshoot	All			0	V	"
EFFICIENCY						
100% Load	0.75V		77.0		%	
"	2.5V		91.0		%	
"	5.0V		95.0		%	
50% Load	0.75V		81.0		%	
"	2.5V		90.5		%	
"	5.0V		94.5		%	



Technical Specification

Input: 6.0 - 16.0V
Outputs: 0.75 - 5.0V
Current: 10A
Package: SIP

ELECTRICAL CHARACTERISTICS (continued) - NQ16W50xKA10 Series

Parameter	Module	Min.	Typ.	Max.	Units	Notes & Conditions
TEMP LIMITS FOR POWER DERATING						
Semiconductor Junction Temperature	All			125	°C	Package rated to 150°C
Board Temperature	All			125	°C	UL rated max operating temp 130°C
FEATURE CHARACTERISTICS						
Switching Frequency 0.75Vout)	All	275	300	325	kHz	Half on small duty cycle (e.g. 16Vin;
ON/OFF Control						
Open Logic (O) ON/OFF Control						See Figure A
Off-State Voltage	All	1.5		6.5	V	
On-State Voltage	All	-3.0		0.6	V	
Input Resistance	All		20		kΩ	
Positive Logic (P) ON/OFF Control						Open collector/drain input; see Figure A
Logic Low Voltage Range	All	-0.2		1.0	V	
Logic High Voltage Range (internal pullup)	All	2.2		Vin	V	
Pull-up Voltage	All		Vin		V	
Pull-up Resistance	All		20		kΩ	
Output Voltage Trim Range	All	0.75		5.5	V	Measured Vout+ to common pins
Output Over-Voltage Protection	All	5.6	6.0	6.4	V	Over full temp range
Over-Temperature Shutdown	All		128		°C	Average PCB Temperature
Over-Temperature Shutdown Restart Hysteresis	All		10		°C	
RELIABILITY CHARACTERISTICS						
Calculated MTBF (Telcordia)	All		15.6		10 ⁶ Hrs.	TR-NWT-000332; 100% load, 200LFM, 40°C T _a
Calculated MTBF (MIL-217)	All		10.0		10 ⁶ Hrs.	MIL-HDBK-217F; 100% load, 200LFM, 40°C T _a
Field Demonstrated MTBF	All				10 ⁶ Hrs.	See our website for details

STANDARDS COMPLIANCE

Parameter	Notes & Conditions
STANDARDS COMPLIANCE	
UL 60950-1:2007	Basic insulation
CAN/CSA-C22.2 No. 60950-1:2007	
EN60950-1:A1:2010	
IEC 61000-4-2	ESD test, 8 kV - NP, 15 kV air - NP (Normal Performance)

Note: An external input fuse must always be used to meet these safety requirements. Contact SynQor for official safety certificates on new releases or download from the SynQor website.

QUALIFICATION TESTING

Parameter	# Units	Test Conditions
QUALIFICATION TESTING		
Life Test	32	95% rated Vin and load, units at derating point, 1000 hours
Vibration	5	10-55 Hz sweep, 0.060" total excursion, 1 min./sweep, 120 sweeps for 3 axis
Mechanical Shock	5	100g minimum, 2 drops in x, y and z axis
Temperature Cycling	10	-40 °C to 100 °C, unit temp. ramp 15 °C/min., 500 cycles
Power/Thermal Cycling	5	Toperating = min to max, Vin = min to max, full load, 100 cycles
Design Marginality	5	Tmin-10 °C to Tmax+10 °C, 5 °C steps, Vin = min to max, 0-105% load
Humidity	5	85 °C, 85% RH, 1000 hours, continuous Vin applied except 5 min/day
Solderability	15 pins	MIL-STD-883, method 2003

OPTIONS

SynQor provides various options for Packaging, Enable Logic, and Feature Set for this family of DC/DC converters. Please consult the last page for information on available options.

PATENTS

SynQor is protected under various patents. Please consult the last page for further details.

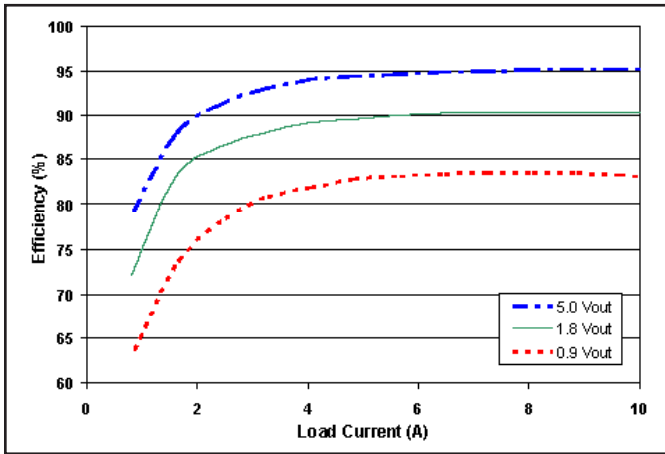

Figure 1: Efficiency at nominal output voltage vs. load current for nominal input voltage at 25°C.

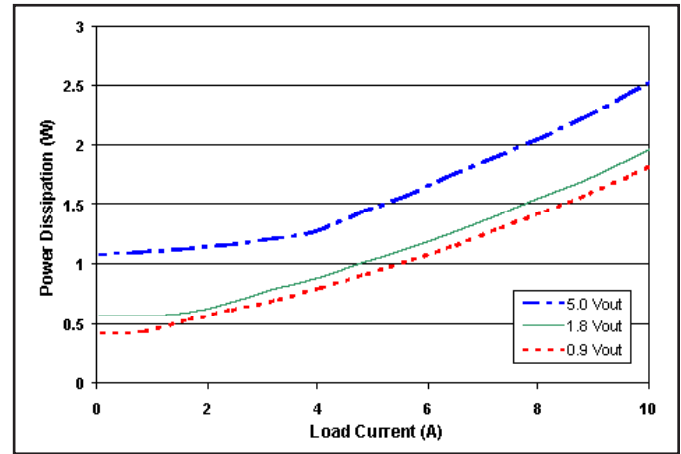

Figure 2: Power dissipation at nominal output voltage vs. load current for nominal input voltage at 25°C.

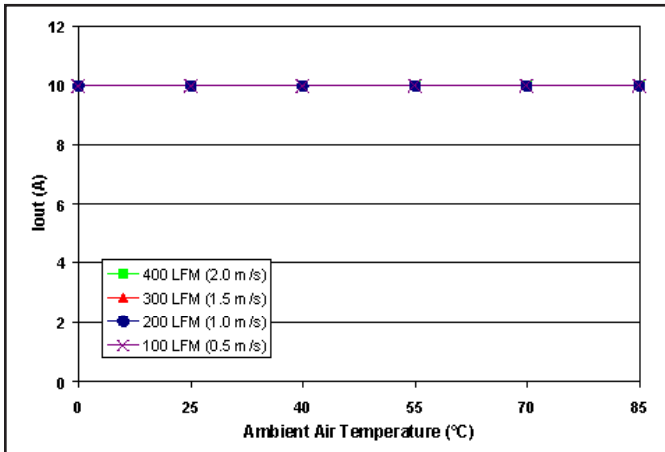

Figure 3: Maximum output power derating curves for 0.75Vo, 1.2Vo, 1.5Vo units under various thermal conditions and nominal input voltage.

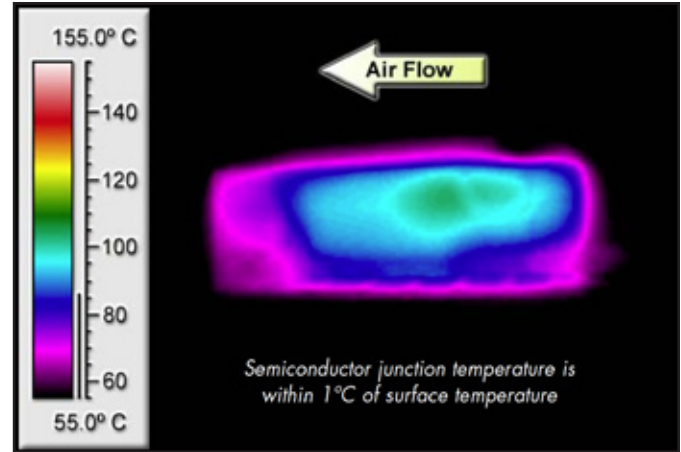

Figure 4: Thermal plot of 0.75Vo, 1.2Vo converters at nominal Vin and 10 amp load current mounted on a 85°C, 6-Layer, 2 oz. copper board (typical installation).

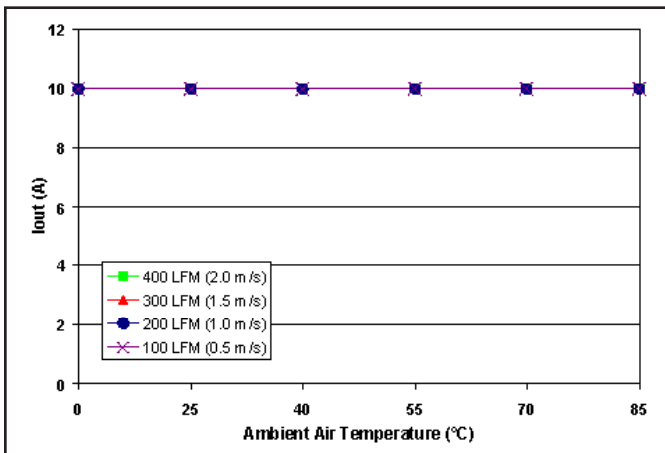

Figure 5: Maximum output power derating curves for 1.8Vo, 2.5Vo units under various thermal conditions and nominal input voltage.

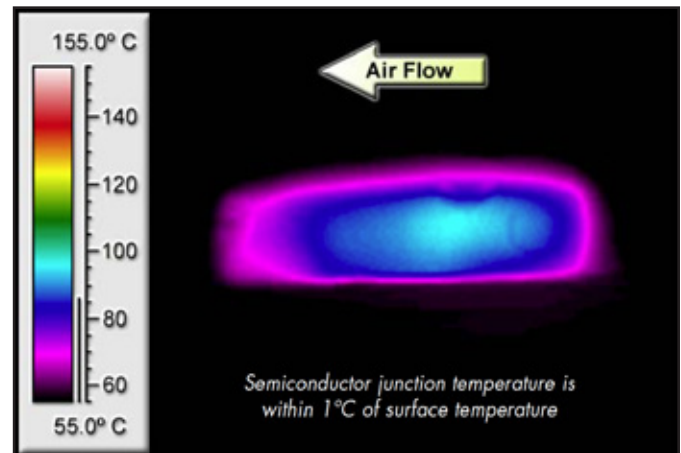

Figure 6: Thermal plot of 1.8Vo, 2.5Vo converters at nominal Vin and 10 amp load current mounted on a 70°C, 6-Layer, 2 oz. copper board (typical installation).

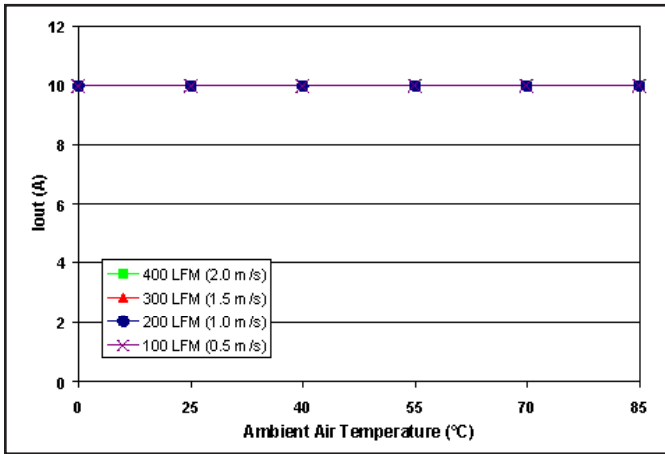

Figure 7: Maximum output power derating curves for 3.3Vo, 5.0Vo units under various thermal conditions and nominal input voltage.

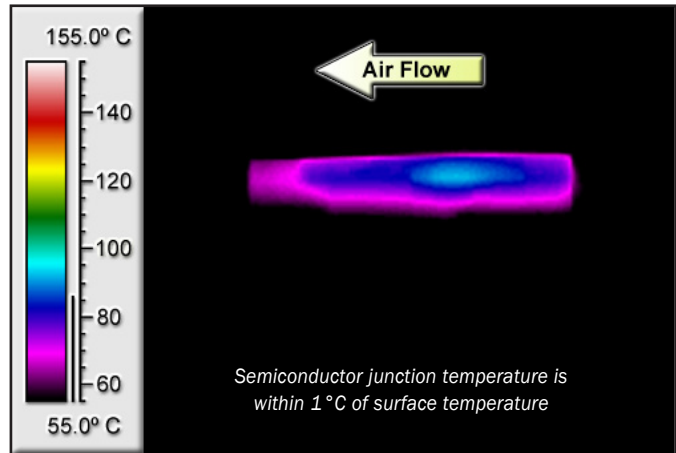

Figure 8: Thermal plot of 3.3Vo, 5.0Vo converters at nominal Vin and 10 amp load current mounted on a 70°C, 6-Layer, 2 oz. copper board (typical installation).

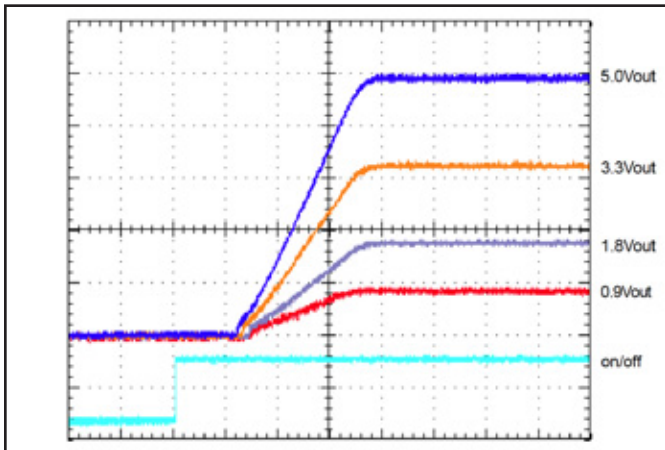

Figure 9: Turn-on transient at full load (resistive load) (2 ms/div).
 Ch 1: ON/OFF input (5V/div)
 Ch 2-4: Vout (1V/div)

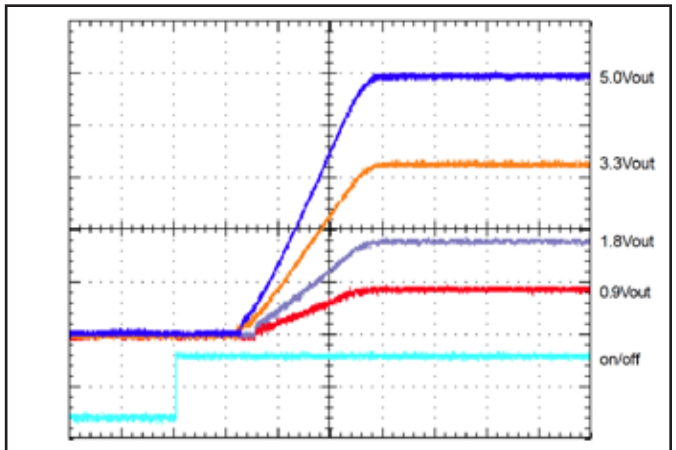

Figure 10: Turn-on transient at zero load (2 ms/div).
 Ch 1: ON/OFF input (5V/div)
 Ch 2-4: Vout (1V/div)

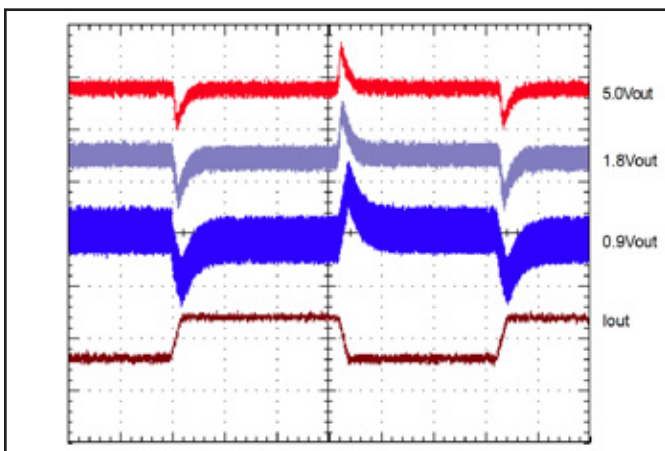

Figure 11: Output voltage response for 0.9V, 1.8V, 5V units to step-change in load current (50-75-50% of Iout max; di/dt=0.1A/μs). Load cap: 100μF, 100mΩ ESR tant, 10μF cer. Ch 1: Iout (10A/div), Ch 2-4: Vout (100mV/div).

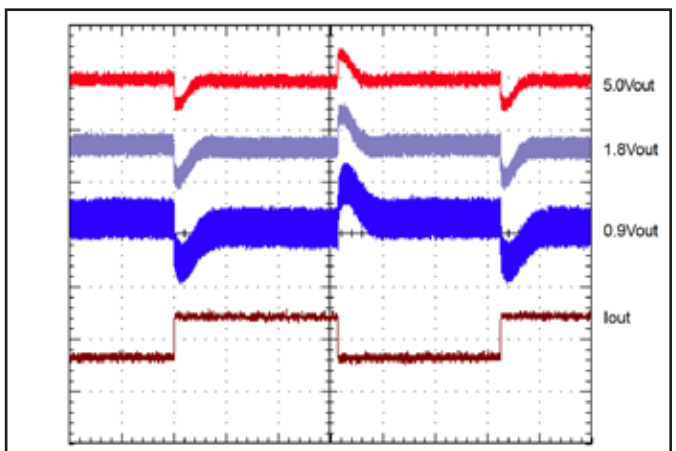

Figure 12: Output voltage response for 0.9V, 1.8V, 5V units to step-change in load current (50-75-50% of Iout max; di/dt=3A/μs). Load cap: 470μF, 100mΩ ESR tant, 10μF cer. Ch 1: Iout (10A/div), Ch 2-4: Vout (100mV/div).

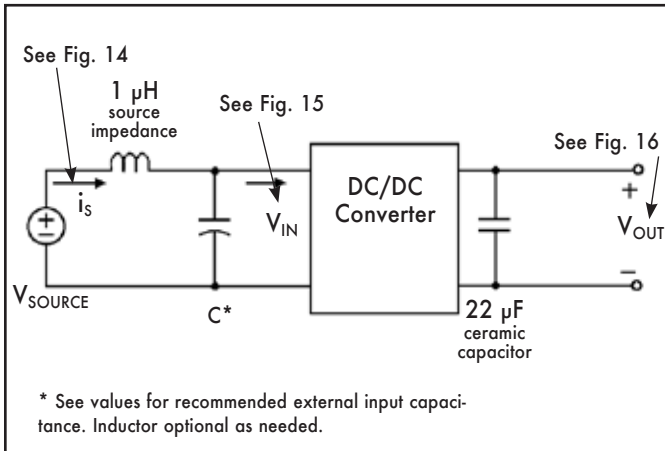

Figure 13: Test set-up diagram showing measurement points for Input Reflected Ripple Current (Figure 14), Input Terminal Ripple Voltage (Figure 15), and Output Voltage Ripple (Figure 16).

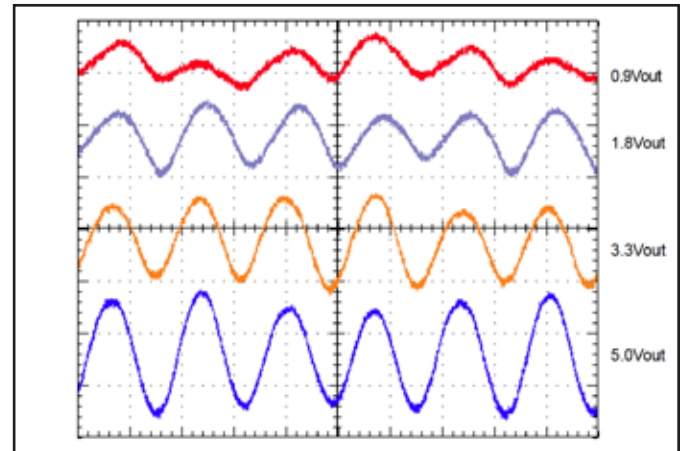

Figure 14: Input Reflected Ripple Current, i_s , through a $1\ \mu\text{H}$ source inductor at nominal input voltage and rated load current (100 mA/div). See Figure 13.

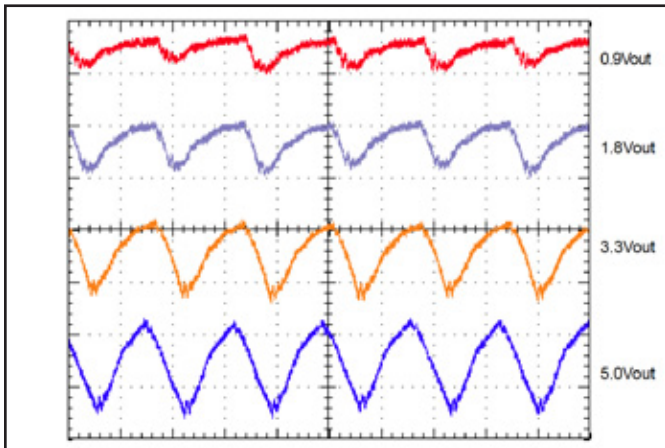

Figure 15: Input Terminal Ripple Voltage at nominal input voltage and rated load current (200 mV/div). Load capacitance: $22\ \mu\text{F}$ ceramic cap. Bandwidth: 20 MHz. See Figure 13.

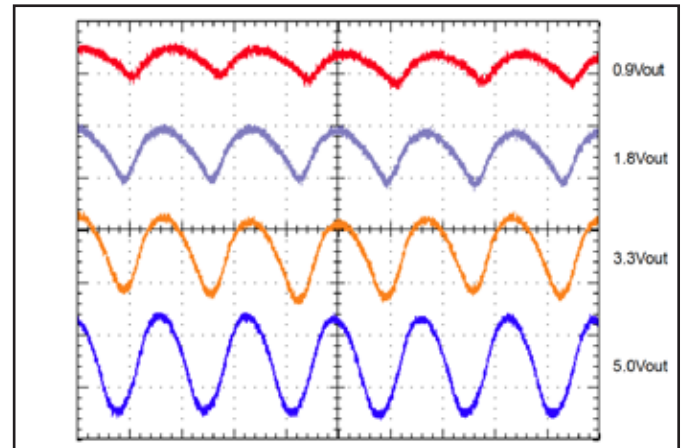

Figure 16: Output Voltage Ripple at nominal input voltage and rated load current (50 mV/div). Load capacitance: $22\ \mu\text{F}$ ceramic cap. Bandwidth: 20 MHz. See Figure 13.

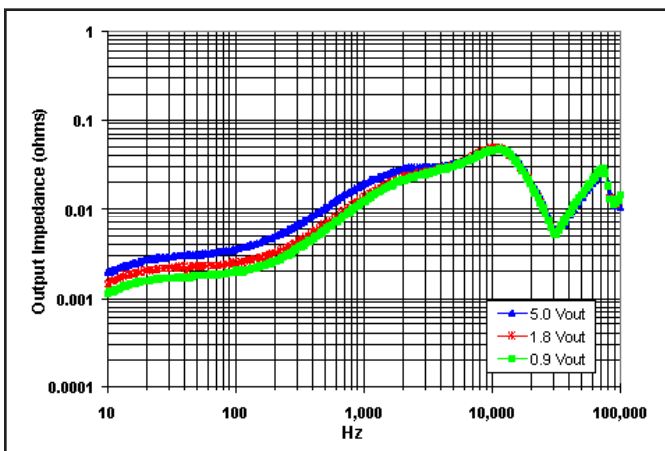

Figure 17: Magnitude of incremental output impedance ($Z_{out} = v_{out}/i_{out}$) for nominal input voltage at full rated power.

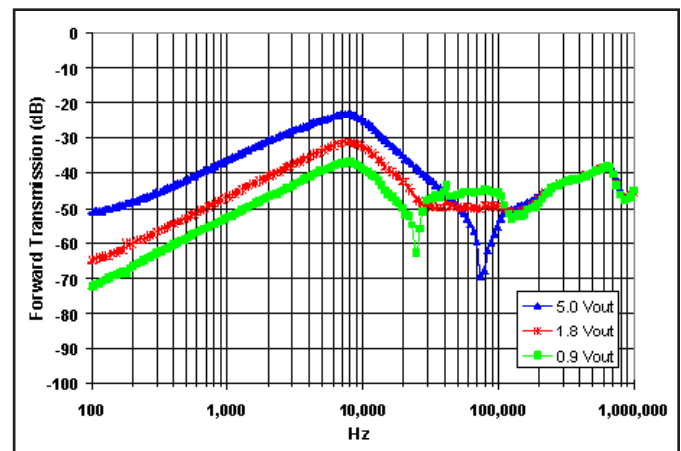

Figure 18: Magnitude of incremental forward transmission ($FT = v_{out}/v_{in}$) for nominal input voltage at full rated power.

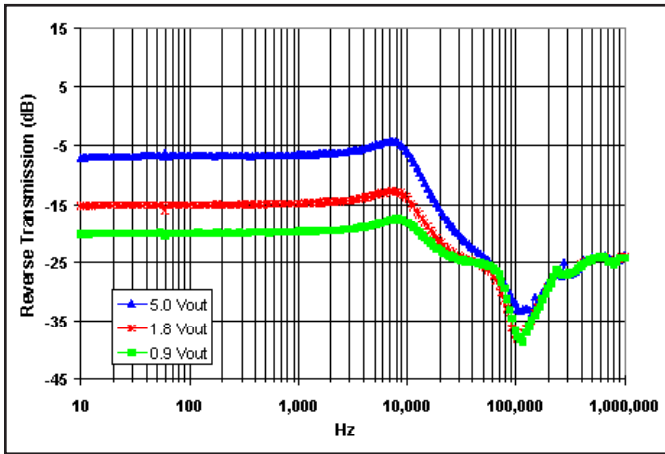

Figure 19: Magnitude of incremental reverse transmission ($RT = i_{in}/i_{out}$) for nominal input voltage at full rated power.

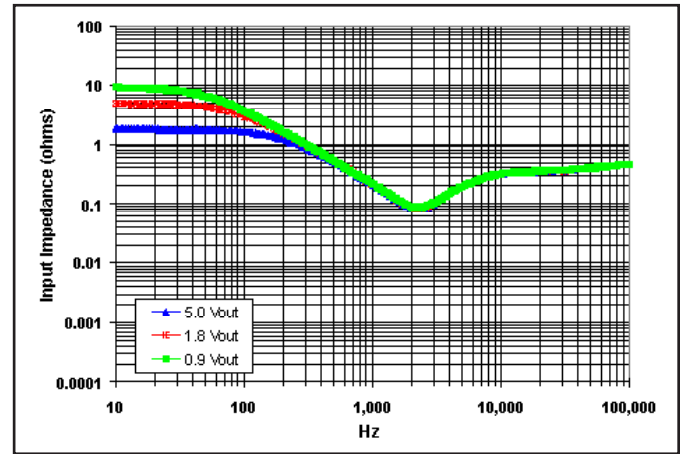

Figure 20: Magnitude of incremental input impedance ($Z_{in} = v_{in}/i_{in}$) for nominal input voltage at full rated power.

BASIC OPERATION AND FEATURES

The NiQor series non-isolated converter uses a buck-converter that keeps the output voltage constant over variations in line, load, and temperature. The NiQor modules employ synchronous rectification for very high efficiency.

Dissipation throughout the converter is so low that it does not require a heatsink or metal baseplate for operation. The NiQor converter can thus be built more simply and reliably using high yield surface mount techniques on a single PCB substrate.

The NiQor series of SIPs and SMT converters uses the established industry standard footprint and pin-out configurations.

CONTROL FEATURES

REMOTE ON/OFF: The ON/OFF input permits the user to control when the converter is on or off. There are currently two options available for the ON/OFF input described in the table below. Others may become available if demand exists.

Option	Description	Pin-Open Float Voltage	Pin-Open Converter State	Pin Action
P Logic	Positive/Open	5	On	Pull Low = Off
N Logic	Negative/Open	0	On	Pull High = Off

OUTPUT VOLTAGE TRIM: The TRIM input permits the user to adjust the output voltage according to the trim range specifications by using an external resistor. If the TRIM feature is not being used, leave the TRIM pin disconnected.

TRIM-UP: To increase the output voltage from the nominal setpoint of 0.7525V using an external resistor, connect the resistor $R_{trim-up}$ between the TRIM and the Ground pin according to the diagram below.

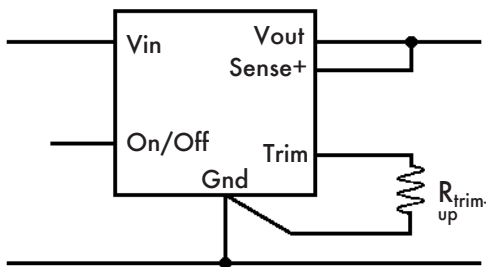

For a desired increase of the nominal output voltage, the value of the resistor should be:

$$R_{trim-up} = \frac{10500}{V_{DES} - 0.7525} - 1000 \quad (\Omega)$$

or

$$V_{OUT} = 0.7525 + \frac{10500}{R_{trim-up} + 1000} \quad (\Omega)$$

where V_{DES} = Desired Output Voltage

To maintain the accuracy of the output voltage over load current, it is vital that any trim-up resistor be terminated directly to the converter's ground foot, not at the connection to the load. A separate Kelvin connection to the PCB pad for the ground foot is optimal. Trim-down resistors should be terminated at the converter's Sense+ pin.

We do not recommend bypassing the trim pin directly to ground with a capacitor. The voltage gain from the trim pin to output is rather large, 15:1. Ground bounce through a bypass capacitor could introduce significant noise to the converter's control circuit.

PROTECTION FEATURES

Input Under-Voltage Lockout: The converter is designed to turn off when the input voltage is too low, helping avoid an input system instability problem, described in more detail in the application note titled "Input System Instability". The lockout circuitry is a comparator with DC hysteresis. When the input voltage is rising, it must exceed the typical Turn-On Voltage Threshold value (listed on the specification page) before the converter will turn on. Once the converter is on, the input voltage must fall below the typical Turn-Off Voltage Threshold value before the converter will turn off.

Output Current Limiting: To provide protection in an output over load fault condition, the unit is equipped with internal over-current protection. When the over-current protection is triggered, the unit enters hiccup mode. The units operate normally once the fault condition is removed.

Internal Over-Voltage Protection: To fully protect from excessive output voltage, the NQ16 series contains an Output Over-Voltage Shutdown circuitry.

This OVP is independent of the trimmed setpoint. As such, the converter's load is protected from faults in the external trim circuitry (such as a trim pin shorted to ground). Since the setpoint of this OVP does not track trim, it is set at 6.0V, in the wide-trim W50 model.

The shutdown point is fixed on standard option. These converters also offer adjustable OVP set point. For more detailed information contact SynQor technical support.

Over-Temperature Shutdown: A temperature sensor on the converter senses the average temperature of the module. The thermal shutdown circuit is designed to turn the converter off when the temperature at the sensed location reaches the Over-Temperature Shutdown value. It will allow the converter to turn on again when the temperature of the sensed location falls by the amount of the Over-Temperature Shutdown Restart Hysteresis value.

APPLICATION CONSIDERATIONS

Input and Output Filtering: SynQor recommends an external input capacitor of either a tantalum, polymer or aluminum electrolytic type on the input of the NQ16 series non-isolated converters. This capacitance and resistance primarily provides damping of the input filter, reduces the source impedance and guarantees input stability (see SynQor application note "Input System Instability"). The input filter is formed by any source or wiring inductance and the converter's input capacitance. The external capacitance also provides an additional benefit of ripple voltage reduction.

A modest sized capacitor would suffice in most conditions, such as a 330 μ F, 16V tantalum, with an ESR of approximately 50 m Ω . The NiQor family converters have an internal ceramic input capacitor to reduce ripple current stress on the external capacitors. An external ceramic capacitor of similar size (330 μ F) with a series resistor of approximately 50 m Ω would also suffice and would provide the filter damping.

Additional ceramic capacitance may be needed on the input, in parallel with the tantalum capacitor, to relieve ripple current stress on the tantalum capacitors. The external capacitance forms a current divider with the 40 μ F internal ceramic capacitance. At 300 kHz., the impedance of the internal capacitance is about 15m Ω capacitive. At that frequency, an SMT 330 μ F tantalum capacitor would have an impedance of about 50m Ω resistive, essentially just the ESR.

In this example, at full load, that would stress the tantalum input capacitor to about 3A rms ripple current, possibly beyond its rating. Placing an additional 40 μ F of ceramic in parallel with that capacitor would reduce the ripple current to about 1.5A, probably within its rating at 85°C. The input ripple current is proportional to load current, so this example should be scaled down according to the actual load current.

Additional input capacitance equal to half of the output capacitance is recommended when operating with more than 1000 μ F of output capacitance on lower voltage outputs when trimming down by more than half of the trim-down allowance (e.g., further than -2.5% on a 0.9V, or -5% on a 1.2V).

Input inductance should be reduced for maintaining input stability when operating with large output capacitance (>1000 μ F). Reducing input inductance to <0.3 μ H provides for good phase margin with up to the 4000 μ F maximum output capacitance. If the input inductance must be increased up to 1 μ H even with large output capacitance (>1000 μ F), an input capacitance equal to or greater than the output capacitance may be needed to compensate the input impedance.

If no inductor is used to isolate the input ripple of the NiQor converters from the source or from inputs of other NiQor converters, then this external capacitance might be provided by the DC/DC converter used as the power source. SynQor's PowerQor series converters typically have tantalum and ceramic output capacitors that would provide the damping.

An input inductor would help isolate the ripple currents and voltages from the source or other NiQor style converters on the voltage supply rail. If an input inductor is used, the recommended capacitance should guarantee stability and control the ripple current for up to 1.0 μ H of input inductance.

The input inductor need not have very high inductance. A value of 250 nanohenries would equate to almost 500 miliohm of series impedance at the switching frequency of 300 kHz. This would be working against an assumed capacitive ESR of 30m Ω on the supply side of the inductor, providing significant isolation and ripple reduction.

No external capacitance is required at the output, however, the ripple voltage can be further reduced if ceramic and tantalum capacitors are added at the output. Since the internal output capacitance is about 50 μ F, approximately that amount of ceramic capacitance would be needed to produce a noticeable reduction in output ripple. The value of the tantalum capacitors is both to provide a high capacitance for pulsed loads and to provide damping of the distribution network with their inherent ESR, which is low, but higher than ceramics. Additional output capacitance in the range of 300-500 μ F is beneficial for reducing the deviation in response to a fast load transient.

Input Over-Voltage Prevention: The power system designer must take precautions to prevent damaging the NiQor converters by input overvoltage. This is another reason to be careful about damping the input filter so that no ringing occurs from an underdamped filter. The voltage must be prevented from exceeding the absolute maximum voltage indicated in the Electrical Specifications section of the data sheet under all conditions of turn-on, turn-off and load transients and fault conditions. The power source should have an over voltage shutdown threshold as close as reasonably possible to the operating point.

Additional protection can come from additional input capacitance, perhaps on the order of 1,000 μ F, but contingent

on the source inductance value. A large source inductance would require more capacitance to keep the input voltage below the absolute maximum, if the load current were interrupted suddenly. This can be caused by either a shutdown of the NiQor from a fault or from the load itself, for example when a card is hot-swapped out, suddenly dropping the load to zero. This is further justification for keeping the source inductance low, as mentioned above. When the power source is configured with remote sensing, the series resistance of the filter inductor and any other conductors or devices between the source and the sense point will result in a voltage drop which, in the event of a load current interruption, would add to the NiQor input voltage.

A TVS device could also be used to clamp the voltage level during these conditions, but the relatively narrow range between operating voltage and the absolute maximum voltage restrict the use of these devices to lower source current levels that will not drive the transient voltage suppressor above the voltage limit when all the source current is flowing into the clamp. A TVS would be a good supplemental control, in addition to careful selection of inductance and capacitance values.

Equivalent Model for Input Ripple: A simple but reasonably accurate model of input ripple is to treat the NiQor input as a pulsed AC current source at 300 kHz, in parallel with a very low ESR capacitor, see Figure E. The peak-to-peak current of the source model is equal to the NiQor load current, representing the peak current in the NiQor's smoothing choke. The capacitor represents the 40µF input ceramic capacitance of the NiQor converter, with a nearly negligible ESR of less than 1 mΩ. A further refinement can be made by setting the duty cycle of the pulsed source to the output voltage divided by the input voltage.

The only error in this simplified model is that it ignores the ripple current in the choke, usually less than 20% of the load current, and it ignores the resistive losses inside the NiQor converter, which would alter the duty cycle very slightly.

The model is a good guide for calculating the effects of external input capacitors and other filter elements on ripple voltage and ripple current stress on capacitors.

Layout Suggestion: When using a fixed output NiQor converter, the designer may choose to use the trim function and would thus be required to reserve board space for a trim resistor. It is suggested that even if the designer does not plan to use the trim function, additional space should be reserved on the board for a trim resistor. This will allow the flexibility to use the wide output voltage trim range NiQor module at a later date. Any trim resistor should connect to the ground or output node at one of the respective pins of the NiQor, so as to prevent the trim level from being affected by load drops through the ground or power planes.

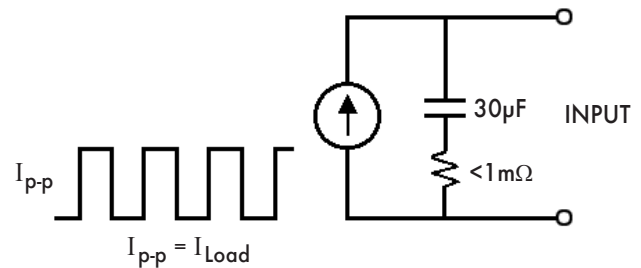

Figure E: Equivalent model for input ripple

OPTIONAL FEATURES

REMOTE SENSE(+) (Pin 3 - Optional): The optional SENSE(+) input corrects for voltage drops along the conductors that connect the converter's output pins to the load.

Pin 3 should be connected to Vout(+) at the point on the board where regulation is desired. A remote connection at the load can adjust for a voltage drop only as large as that specified in this datasheet, that is

$$V_{out(+)} - \text{SENSE}(+) \leq \text{Sense Range \%} \times V_{out}$$

Pin 3 must be connected for proper regulation of the output voltage. If these connections are not made, the converter will deliver an output voltage that is slightly higher than its specified value.

Note: the output over-voltage protection circuit senses the voltage across the output (pins 1, 2 and 4) to determine when it should trigger, not the voltage across the converter's sense lead (pin 3).

RoHS Compliance: The EU led RoHS (Restriction of Hazardous Substances) Directive bans the use of Lead, Cadmium, Hexavalent Chromium, Mercury, Polybrominated Biphenyls (PBB), and Polybrominated Diphenyl Ether (PBDE) in Electrical and Electronic Equipment. This SynQor product is 6/6 RoHS compliant. For more information please refer to SynQor's RoHS addendum available at our RoHS Compliance / Lead Free Initiative web page or e-mail us at rohs@synqor.com.



Technical Specification

Input: 6.0 - 16.0V
Outputs: 0.75 - 5.0V
Current: 10A
Package: SIP

PART NUMBERING SYSTEM

The part numbering system for SynQor's NiQor DC/DC converters follows the format shown in the example below.

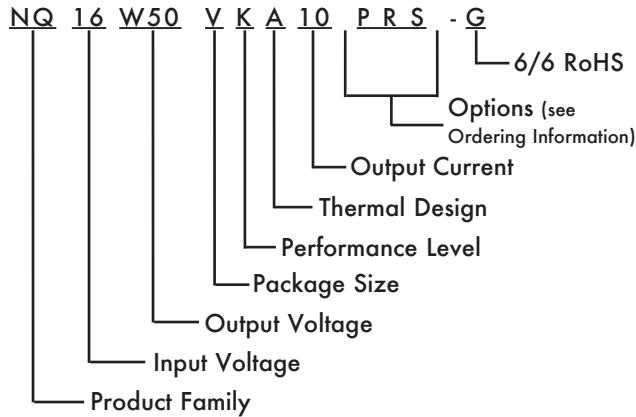

The first 12 characters comprise the base part number and the last 3 characters indicate available options. A "-G" suffix indicates the product is 6/6 RoHS compliant.

Application Notes

A variety of application notes and technical white papers can be downloaded in pdf format from our website.

ORDERING INFORMATION

The tables below show the valid model numbers and ordering options for converters in this product family. When ordering SynQor converters, please ensure that you use the complete 15 character part number consisting of the 12 character base part number and the additional 3 characters for options. A "-G" suffix indicates the product is 6/6 RoHS compliant.

Model Number	Input Voltage	Output Voltage	Max Output Current
NQ16W50pKA10xyz-G	6.0 - 16V	0.75 - 5.0V	10A

The following option choices must be included in place of the x y z spaces in the model numbers listed above.

Packaging: p	Options Description: xyz		
Packaging	Enable Logic	Pin Style	Feature Set
V- Vert Mount SIP	P- Pos./Open	R - 0.160" (Standard)	S - Sense
H- Horiz. Mount SIP	O- Neg./Open		N - None

PATENTS

SynQor holds the following U.S. patents, one or more of which apply to each product listed in this document. Additional patent applications may be pending or filed in the future.

5,999,417	6,222,742	6,545,890	6,577,109	6,594,159	6,731,520	6,894,468
6,896,526	6,927,987	7,050,309	7,072,190	7,085,146	7,119,524	7,269,034
7,272,021	7,272,023	7,558,083	7,564,702	7,765,687	7,787,261	8,023,290

Contact SynQor for further information:

Phone: 978-849-0600
Toll Free: 888-567-9596
Fax: 978-849-0602
E-mail: power@synqor.com
Web: www.synqor.com
Address: 155 Swanson Road
 Boxborough, MA 01719
 USA

Warranty

SynQor offers a three (3) year limited warranty. Complete warranty information is listed on our website or is available upon request from SynQor.

Information furnished by SynQor is believed to be accurate and reliable. However, no responsibility is assumed by SynQor for its use, nor for any infringements of patents or other rights of third parties which may result from its use. No license is granted by implication or otherwise under any patent or patent rights of SynQor.