

## MILITARY COTS EMI FILTER

<b>-70V to +70V</b> Continuous Input	<b>10A</b> Output Current	<b>60mΩ @ 100°C</b> Max. DC Resistance	<b>&gt;80dB @ 500kHz</b> Differential Attenuation
---	------------------------------	---	--

**FULL POWER OPERATION: -55°C to +100°C**

The Mil-COTS series of EMI filters brings SynQor's field proven technology and manufacturing expertise to the industrial power application marketplace. SynQor's innovative packaging approach ensures survivability in the most hostile environments. These filters have high differential-mode and common-mode attenuation, low DC resistance, and a stabilizing bulk capacitor resistor. They follow conservative component derating guidelines and they are designed and manufactured to the highest standards.

# MilCOTS<sup>™</sup>

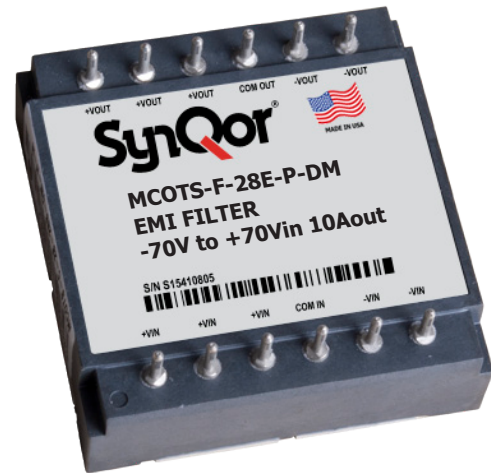

Designed and Manufactured in the USA

### Operational Features

- 10A output current
- Very low DC resistance
- >80 dB differential-mode attenuation at 500kHz
- >60dB common-mode attenuation at 500kHz
- Stabilizing bulk capacitor and damping resistor included
- All capacitors are X7R multi-layer ceramic
- Designed to meet all MIL-STD 461 EMI requirements (D,E,F)

### Mechanical Features

- Size: 1.55" x 1.52" x 0.50" (39.4 x 38.6 x 12.7 mm)
- Total weight: 1.97 oz (56g)
- Flanged baseplate version available

### Safety Features

- 1000V input/output to case isolation
- Certified 60950-1 requirement for basic insulation (see Standards and Qualifications page)

### In-Line Manufacturing Process

- AS9100 and ISO 9001 Certified Facility
- Full component traceability

### Screening Qualifications

- AS9100 and ISO 9001 certified facility
- Qualified to MIL-STD-810
- Available with S-Grade or M-Grade screening
- Pre-cap inspection per IPC-A-610, Class III
- Temperature cycling per MIL-STD-883, Method 1010, Condition B, 10 cycles
- Burn-In at 100 °C baseplate temperature
- Final visual inspection per MIL-STD-883, Method 2009
- Full component traceability



**MCOTS-F-28E-P-DM**

**Current: 10A**

### Fundamental Circuit Diagram

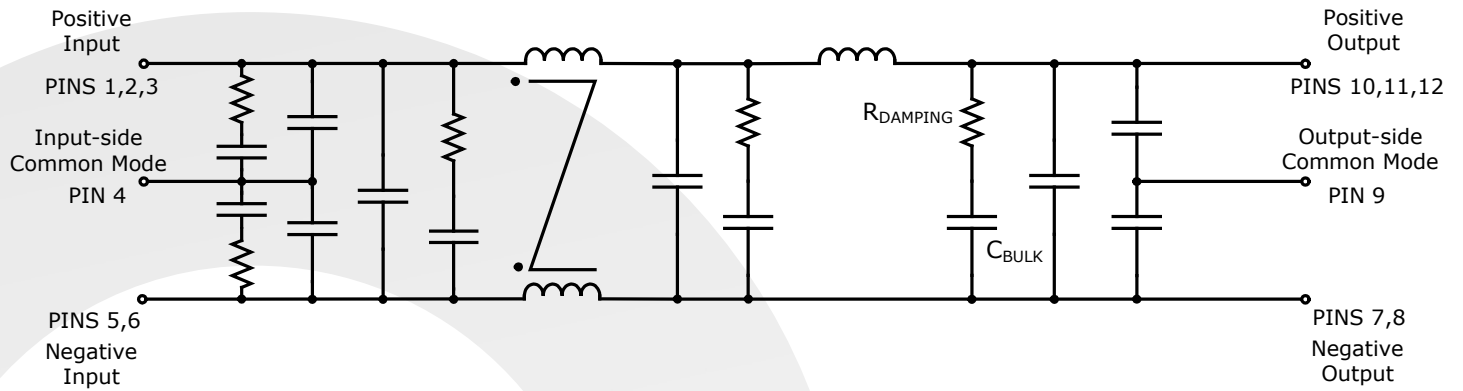

### Typical Connection Diagram

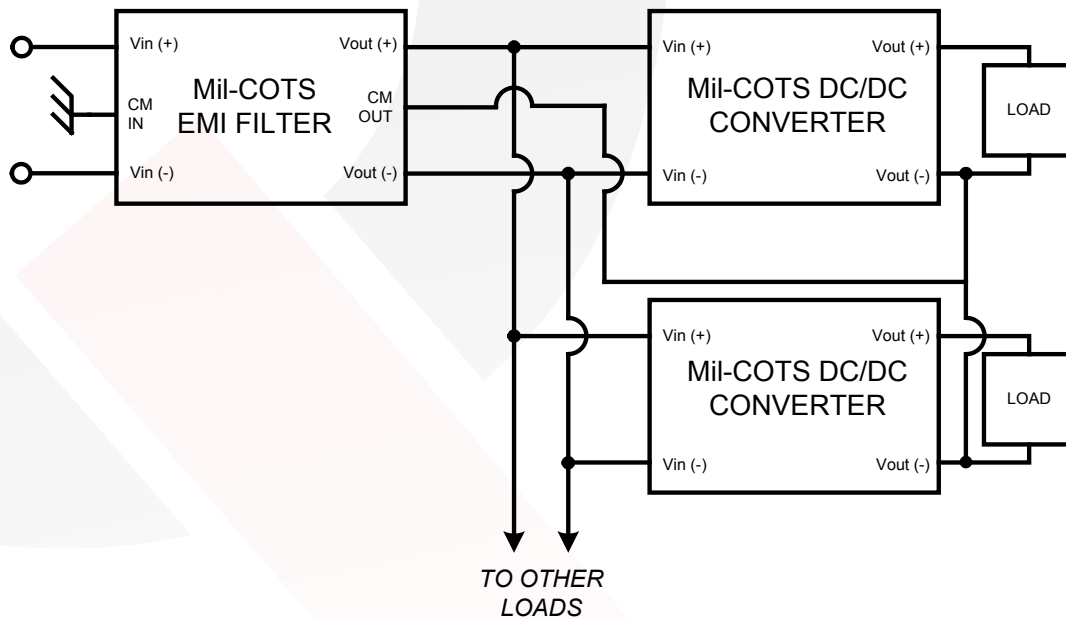

## MCOTS-F-28E-P-DM ELECTRICAL CHARACTERISTICS

Vin = 28V, Iout = 10A unless otherwise specified. Specifications subject to change without notice.

Parameter	Min.	Typ.	Max.	Units	Notes & Conditions
<b>ABSOLUTE MAXIMUM RATINGS</b>					
Input Voltage					
Continuous	-70		70	V	
Transient (≤ 1 s)	-100		100	V	
Isolation Voltage	-1000		1000	V	Input/Output to Common-mode pins
Output Current			10	A	
Operating Case Temperature	-55		100	°C	Baseplate Temperature
Storage Case Temperature	-65		135	°C	
<b>RECOMMENDED OPERATION CONDITIONS</b>					
Input Voltage					
Continuous	-70		70	V	
Transient (1 s, Rs* = 0 Ω)	-80		80	V	* Rs = Source Impedance
Output Power (continuous)	-10		10	A	
<b>ELECTRICAL CHARACTERISTICS</b>					
Output Voltage (continuous)	Vout = Vin - (Iin x Rdc)			V	
DC Resistance (Rdc)					Total
Tcase = 25°C			40	mΩ	
Tcase = 100°C			60	mΩ	
Power Dissipation					10A output current
Tcase = 25°C			4	W	
Tcase = 100°C			6	W	
Total Differential-Mode Capacitance		54		μF	Measured across input and output pins
Total Common-Mode Capacitance		0.29		μF	Measured between any pin and common-mode pins
Bulk Capacitor		41		μF	
Damping Resistor		0.3		Ω	
Noise Attenuation					
Differential-Mode		80		dB	
Common-Mode		60		dB	
Isolation Resistance	100			MΩ	Any pin to common-mode pins
<b>ISOLATION CHARACTERISTICS</b>					
Isolation Voltage (any pin to case)					
Continuous	-1000		1000	V	
Transient (≤ 100 μs)	-1000		1000	V	
Isolation Resistance (any pin to case)	100			MΩ	
<b>INPUT VOLTAGE SPIKE SUPPRESSION</b>					
Output Voltage Deviation due to a Spike					
Input Voltage Spike (Centered on Vin)					
±250V, 100μs, Emax=15mJ	-5		5	ΔV	MIL-STD-1275D
±600V, 100μs, Rs* = 50 Ω	-5		10	ΔV	RTCA/DO-160E/F/G
<b>RELIABILITY CHARACTERISTICS</b>					
Calculated MTBF (MIL-STD-217F2)					
GB @ Tcase = 70°C		24.6		10 <sup>6</sup> Hrs.	
GM @ Tcase = 70°C		1.29		10 <sup>6</sup> Hrs.	
Demonstrated MTBF				10 <sup>6</sup> Hrs.	See our website for details
<b>WEIGHT CHARACTERISTICS</b>					
Device Weight		56		g	

\* Rs = Source Impedance



### Basic Operation and Features

This module is a multi-stage differential-mode and common-mode passive EMI filter designed to interface a power source with one or more Mil-COTS DC-DC converters (or other loads that create EMI). Each stage of this filter is well damped to avoid resonances and oscillations, and only X7R multi-layer ceramic capacitors are used. This Mil-COTS EMI filter includes a large bulk capacitor with a series damping resistor to correct for the unstabilizing effect of a converter's negative input resistance. A white paper discussing this negative input resistance and the need for corrective damping can be found on the SynQor website (see Input System Instability application note).

When used with SynQor's DC-DC converters, the Mil-COTS EMI filter is designed to pass all of the relevant MIL-STD-461C/D/E/F requirements. The MIL-STD-461 Compliance Matrix Table lists these requirements and describes the setup used to pass them.

A typical application would place the Mil-COTS filter close to the input of the DC-DC converter. The input-side common-mode pin would be connected to the chassis ground that is common with the system input line filter or other earthed point used for EMI measurement. The output-side common-mode pin would be connected to the output ground plane of the power converters with as low inductance a path as possible. There are no connections to the metal baseplate, which may also be connected to the chassis ground if desired.

Do not connect the outputs of multiple Mil-COTS filters in parallel. Connecting filters in this manner may result in slightly unequal currents to flow in the positive and return paths of each filter. These unequal currents may cause the internal common-mode chokes to saturate and thus cause degraded common-mode rejection performance.

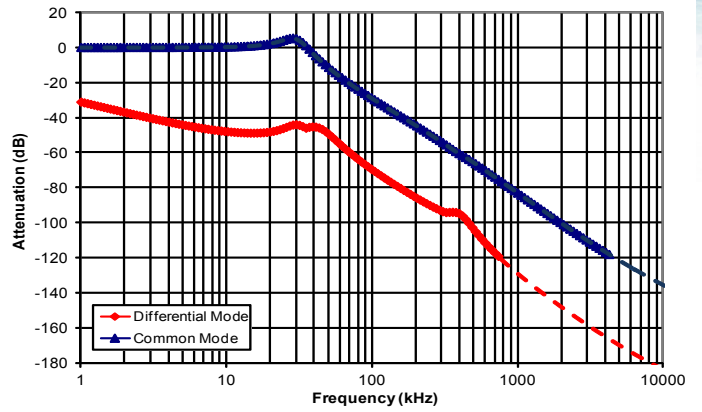

Figure A: Simulation of calculated common-mode and differential-mode current attenuation. The plots show the ratio of the measured current in a 50Ω LISN sensing port connected to pins 1-6 to the noise current injected into pins 7-12 as shown in Figures B & C.

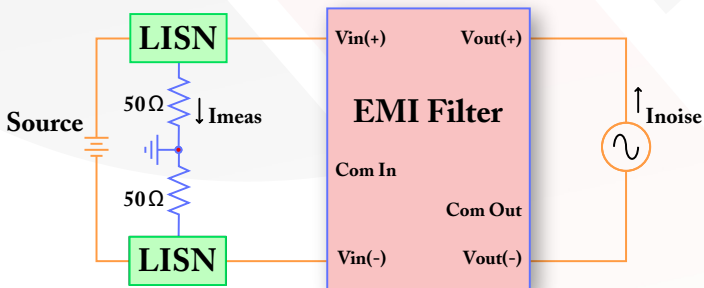

Figure B: Differential-Mode Current Attenuation,  $I_{meas} / I_{noise}$

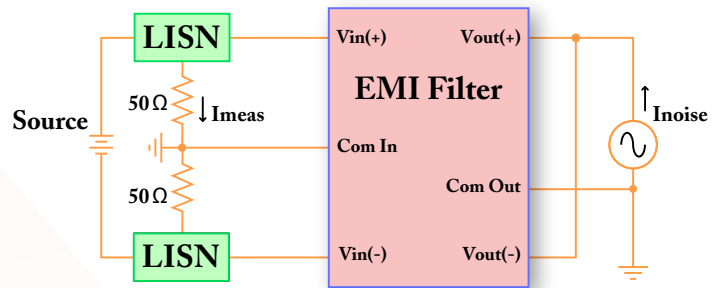

Figure C: Common-Mode Current Attenuation,  $I_{meas} / I_{noise}$



**MCOTS-F-28E-P-DM**

**Current: 10A**

## Encased Mechanical Diagram

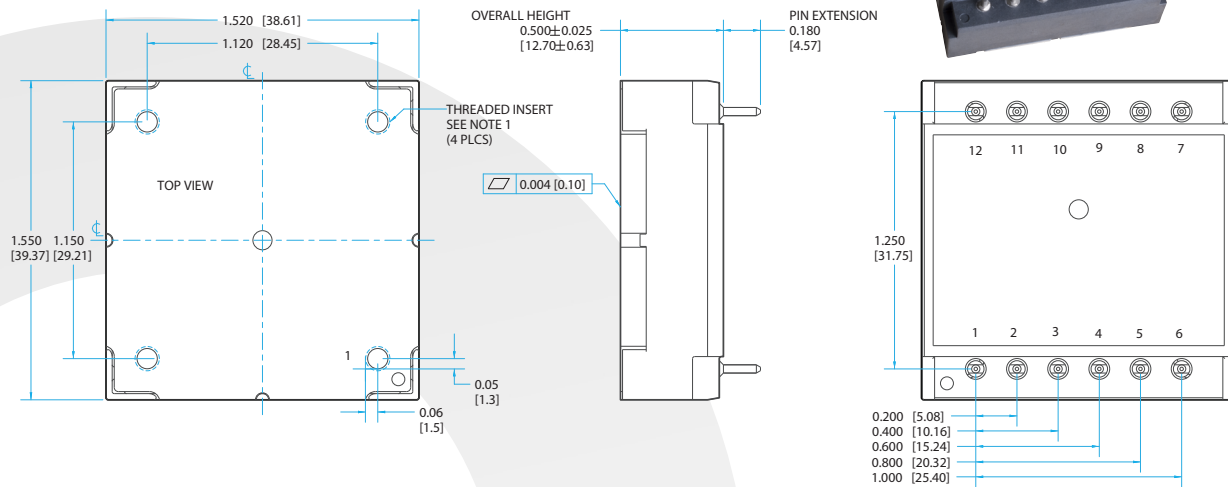

### NOTES

1. APPLIED TORQUE PER M3 SCREW 6in-lb RECOMMENDED SCREW SHOULD NOT EXCEED 0.100" (2.54mm) DEPTH BELOW THE SURFACE OF THE BASEPLATE.
2. BASEPLATE FLATNESS TOLERANCE IS 0.004" (.10mm) TIR FOR
3. PINS 1-12 ARE 0.040" (1.02mm) DIA. WITH 0.080" (2.03mm) DIA. STANDOFFS.
4. WORKMANSHIP: MEETS OF EXCEEDS IPC-A610
5. ALL PINS: MATERIAL: COPPER ALLOY FINISH: MATTE TIN OVER NICKEL PLATE
6. WEIGHT: 1.97 oz (56g)
7. ALL DIMENSIONS IN INCHES(mm)  
TOLERANCES: X.XXIN +/-0.02 (X.Xmm +/-0.5mm)  
X.XXXIN +/-0.010 (X.XXmm +/-0.25mm)

### PIN DESIGNATIONS

Pin	Name	Function
1	Vin (+)	Positive input voltage
2	Vin (+)	Positive input voltage
3	Vin (+)	Positive input voltage
4	COM IN	Input-side Common-mode
5	Vin (-)	Negative input voltage
6	Vin (-)	Negative input voltage
7	Vout (-)	Negative output voltage
8	Vout (-)	Negative output voltage
9	COM OUT	Output-side Common-mode
10	Vout (+)	Positive output voltage
11	Vout (+)	Positive output voltage
12	Vout (+)	Positive output voltage

Pin Designation Notes:

- 1: Pin out differs from other Mil-COTS products.

## Flanged Encased Mechanical Diagram

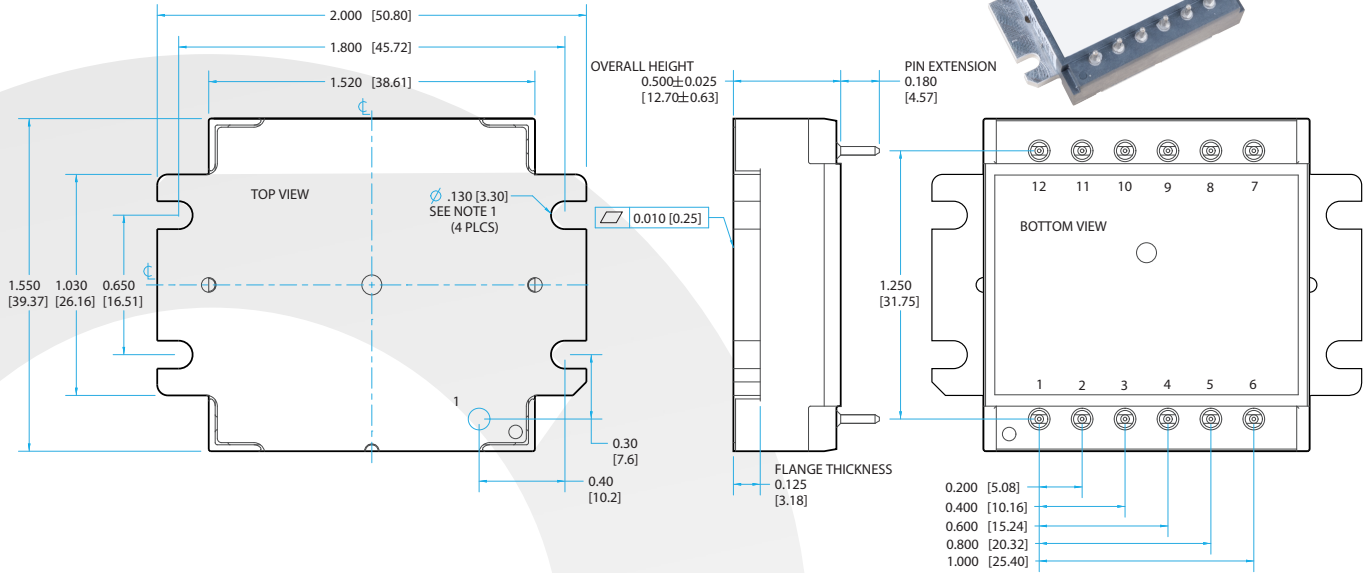

### NOTES

1. APPLIED TORQUE PER M3 OR 4-40 SCREW 6in-lb RECOMMENDED
2. BASEPLATE FLATNESS TOLERANCE IS 0.010" (.25mm) TIR FOR SURFACE.
3. PINS 1-12 ARE 0.040" (1.02mm) DIA. WITH 0.080" (2.03mm) DIA. STANDOFFS.
4. ALL PINS: MATERIAL: COPPER ALLOY  
FINISH: MATTE TIN OVER NICKEL PLATE
5. ALTERNATIVE PIN LENGTH MAYBE AVAILABLE. CHECK WITH FACTORY
6. WEIGHT: 2.08 oz (59g)
7. ALL DIMENSIONS IN INCHES(mm)  
TOLERANCES: X.XXIN +/-0.02 (X.Xmm +/-0.5mm)  
X.XXXIN +/-0.010 (X.XXmm +/-0.25mm)

### PIN DESIGNATIONS

Pin	Name	Function
1	Vin (+)	Positive input voltage
2	Vin (+)	Positive input voltage
3	Vin (+)	Positive input voltage
4	COM IN	Input-side Common-mode
5	Vin (-)	Negative input voltage
6	Vin (-)	Negative input voltage
7	Vout (-)	Negative output voltage
8	Vout (-)	Negative output voltage
9	COM OUT	Output-side Common-mode
10	Vout (+)	Positive output voltage
11	Vout (+)	Positive output voltage
12	Vout (+)	Positive output voltage

#### Pin Designation Notes:

- 1: Pin out differs from other Mil-COTS products.

**Mil-COTS Qualification**

Test Name	Details	# Tested (# Failed)	Consistent with MIL-STD-883F Method
<b>Life Testing</b>	Visual, mechanical and electrical testing before, during and after 1000 hour burn-in @ full load	15 (0)	Method 1005.8
<b>Shock-Vibration</b>	Visual, mechanical and electrical testing before, during and after shock and vibration tests	5 (0)	MIL-STD-202, Methods 201A & 213B
<b>Humidity</b>	+85 °C, 95% RH, 1000 hours, 2 minutes on / 6 hours off	8 (0)	Method 1004.7
<b>Temperature Cycling</b>	500 cycles of -55 °C to +100 °C (30 minute dwell at each temperature)	10 (0)	Method 1010.8, Condition A
<b>Solderability</b>	15 pins	15 (0)	Method 2003
<b>DMT</b>	-65 °C to +110 °C across full line and load specifications in 5 °C steps	7 (0)	
<b>Altitude</b>	70,000 feet (21 km), see Note	2 (0)	

Note: A conductive cooling design is generally needed for high altitude applications because of naturally poor convective cooling at rare atmospheres.

**Mil-COTS Converter and Filter Screening**

Screening	Process Description	S-Grade	M-Grade
<b>Baseplate Operating Temperature</b>		-55 °C to +100 °C	-55 °C to +100 °C
<b>Storage Temperature</b>		-65 °C to +135 °C	-65 °C to +135 °C
<b>Pre-Cap Inspection</b>	IPC-A-610, Class III	•	•
<b>Temperature Cycling</b>	MIL-STD-883F, Method 1010, Condition B, 10 Cycles		•
<b>Burn-In</b>	100 °C Baseplate	12 Hours	96 Hours
<b>Final Electrical Test</b>	100%	25 °C	-55 °C, +25 °C, +100 °C
<b>Final Visual Inspection</b>	MIL-STD-883F, Method 2009	•	•

**STANDARDS COMPLIANCE**
**Parameter** **Notes & Conditions**
**STANDARDS COMPLIANCE**

UL 60950-1	Basic Insulation
CAN/CSA C22.2 No. 60950-1	
EN 60950-1	

Note: An external input fuse must always be used to meet these safety requirements. Contact SynQor for official safety certificates on new releases or download from the SynQor website.



**MCOTS-F-28E-P-DM**

**Current: 10A**

**Mil-COTS MIL-STD-810G Qualification Testing**

MIL-STD-810G Test	Method	Description
<b>Fungus</b>	508.6	Table 508.6-I
<b>Altitude</b>	500.5 - Procedure I	Storage: 70,000 ft / 2 hr duration
	500.5 - Procedure II	Operating: 70,000 ft / 2 hr duration; Ambient Temperature
<b>Rapid Decompression</b>	500.5 - Procedure III	Storage: 8,000 ft to 40,000 ft
<b>Acceleration</b>	513.6 - Procedure II	Operating: 15 g
<b>Salt Fog</b>	509.5	Storage
<b>High Temperature</b>	501.5 - Procedure I	Storage: 135 °C / 3 hrs
	501.5 - Procedure II	Operating: 100 °C / 3 hrs
<b>Low Temperature</b>	502.5 - Procedure I	Storage: -65 °C / 4 hrs
	502.5 - Procedure II	Operating: -55 °C / 3 hrs
<b>Temperature Shock</b>	503.5 - Procedure I - C	Storage: -65 °C to 135 °C; 12 cycles
<b>Rain</b>	506.5 - Procedure I	Wind Blown Rain
<b>Immersion</b>	512.5 - Procedure I	Non-Operating
<b>Humidity</b>	507.5 - Procedure II	Aggravated cycle @ 95% RH (Figure 507.5-7 aggravated temp - humidity cycle, 15 cycles)
<b>Random Vibration</b>	514.6 - Procedure I	10 - 2000 Hz, PSD level of 1.5 g <sup>2</sup> /Hz (54.6 g <sub>rms</sub> ), duration = 1 hr/axis
<b>Shock</b>	516.6 - Procedure I	20 g peak, 11 ms, Functional Shock (Operating no load) (saw tooth)
	516.6 - Procedure VI	Bench Handling Shock
<b>Sinusoidal vibration</b>	514.6 - Category 14	Rotary wing aircraft - helicopter, 4 hrs/axis, 20 g (sine sweep from 10 - 500 Hz)
<b>Sand and Dust</b>	510.5 - Procedure I	Blowing Dust
	510.5 - Procedure II	Blowing Sand

**EMI**

**Military Standard 461 Compliance Matrix**

This table shows the MIL-STD-461 requirements/limits that will be met\* by the stand-alone setups indicated below:

Mil-Std-461	MIL-STD-461D/E/F	
	Requirement	Most Stringent Limit Listed
<b>Conducted Emissions</b>	CE101	Submarine
	CE102	Basic Curve
<b>Conducted Susceptibility</b>	CS101	Curve #2
	CS106	461F Only
	CS114	Curve #5
	CS115	Basic Waveform
	CS116	Imax = 10A
<b>Radiated Emissions</b>	RE101	Navy
	RE102	Fixed Wing Internal, >25 meters Nose to Tail

\* Susceptibility requirements/limits are considered to be met as long as transient deviations in the converter's output voltage remain within ±10% of its initial value.

<b>MCOTS</b>	<ul style="list-style-type: none"> <li>• MCOTS-F-28-P-DM Filter</li> <li>• MCOTS-28-05S-DM Converter</li> <li>• 50W Resistive load</li> </ul>
--------------	---





## Ordering Information

Example MCOTS-F-28E-P-DM-N-S

Family	Product	Input Voltage	Filter Type	Package	Thermal Design	Screening Level
MCOTS	F: Filter	<b>28:</b> -40V to +40V <b>28E:</b> -70V to +70V <b>48:</b> -80V to +80V <b>270:</b> -500V to +500V	<b>P:</b> Passive <b>T:</b> Transient	<b>DM:</b> Demi Brick <b>QT:</b> Quarter Brick <b>HT:</b> Half Brick	<b>N:</b> Normal Threaded <b>D:</b> Normal Non-Threaded <b>F:</b> Flanged	<b>S:</b> S-Grade <b>M:</b> M-Grade

Not all combinations make valid part numbers, please contact SynQor for availability. See the Product Summary web page for more options.

### Application Notes

A variety of application notes and technical white papers can be downloaded in pdf format from our website.

### Contact SynQor for further information and to order:

**Phone:** 978-849-0600  
**Toll Free:** 888-567-9596  
**Fax:** 978-849-0602  
**E-mail:** [power@synqor.com](mailto:power@synqor.com)  
**Web:** [www.synqor.com](http://www.synqor.com)  
**Address:** 155 Swanson Road  
 Boxborough, MA 01719  
 USA

### PATENTS

SynQor holds numerous U.S. patents, one or more of which apply to most of its power conversion products. Any that apply to the product(s) listed in this document are identified by markings on the product(s) or on internal components of the product(s) in accordance with U.S. patent laws. SynQor's patents include the following:

5,999,417	6,222,742	6,545,890	6,594,159	6,894,468	6,896,526
6,927,987	7,050,309	7,072,190	7,085,146	7,119,524	7,269,034
7,272,021	7,272,023	7,558,083	7,564,702	7,765,687	7,787,261
8,023,290	8,149,597	8,493,751	8,644,027	9,143,042	

### Warranty

SynQor offers a two (2) year limited warranty. Complete warranty information is listed on our website or is available upon request from SynQor.