



MCOTS-N-12-Q3P1N-QT Quad Output Quarter-Brick

Military COTS Non-Isolated DC-DC Converters

6-15 V Continuous Input	0.8V to 5V Positive Outputs	30A Each Positive Output	-3.0V to -13.5V Negative Output	1A Negative Output
-----------------------------------	---------------------------------------	------------------------------------	---	------------------------------

The MCOTS-N QUAD Output non-isolated dc-dc converter employs synchronous rectification to achieve extremely high conversion efficiency in a quarter brick package. The module generates three positive output voltages, and one negative output voltage. The MCOTS-N QUAD Output Brick converter can be used in traditional DPA (distributed power architecture) systems that require a more rugged design. All four outputs have a wide output trim range, creating a high degree of flexibility for the user.

MilCOTS™



Designed and manufactured in the USA

Operational Features

- High efficiency, up to 93% at full rated load current
- Delivers up to 30A on each positive output and 1A on the negative output
- Input Voltage Range: 6-15 Vdc
- Output Voltage Range:
positive outputs: 0.8V to 5V,
negative output: -3.0V to -13.5V

Protection Features

- Over-current shutdown (all outputs)
- Thermal shutdown (all outputs)
- Over-voltage shutdown (positive outputs only)
- Input under-voltage lockout (positive outputs only)

Control Features

- On/Off control for each output
- Output voltage trim for each output permits custom voltages
- Remote Sense (positive outputs only)

Mechanical Features

- Quarter-brick form factor.
- Standard size: 1.54" x 2.39" x 0.50"
(39.0 x 60.6 x 12.7 mm)
- Weight: 3.27oz. (93g)

Screening / Qualification

- AS9100 and ISO 9001 certified facility
- Qualified to MIL-STD-810
- Available with S-Grade or M-Grade screening
- Pre-cap inspection per IPC-610, Class III
- Temperature cycling per MIL-STD-883, Method 1010, Condition B, 10 cycles
- Final visual inspection per MIL-STD-883, Method 2009
- Full component traceability

Contents

	Page No
Technical Connection Diagram	2
Technical Specification	3
Application Section	8
Encased Mechanical	11
Encased Mechanical with Flange	12
Qualification & Screening	13
Ordering Information	14



MCOTS-N-12-Q3P1N-QT
Quad Output
Quarter-Brick

Technical Connection Diagram

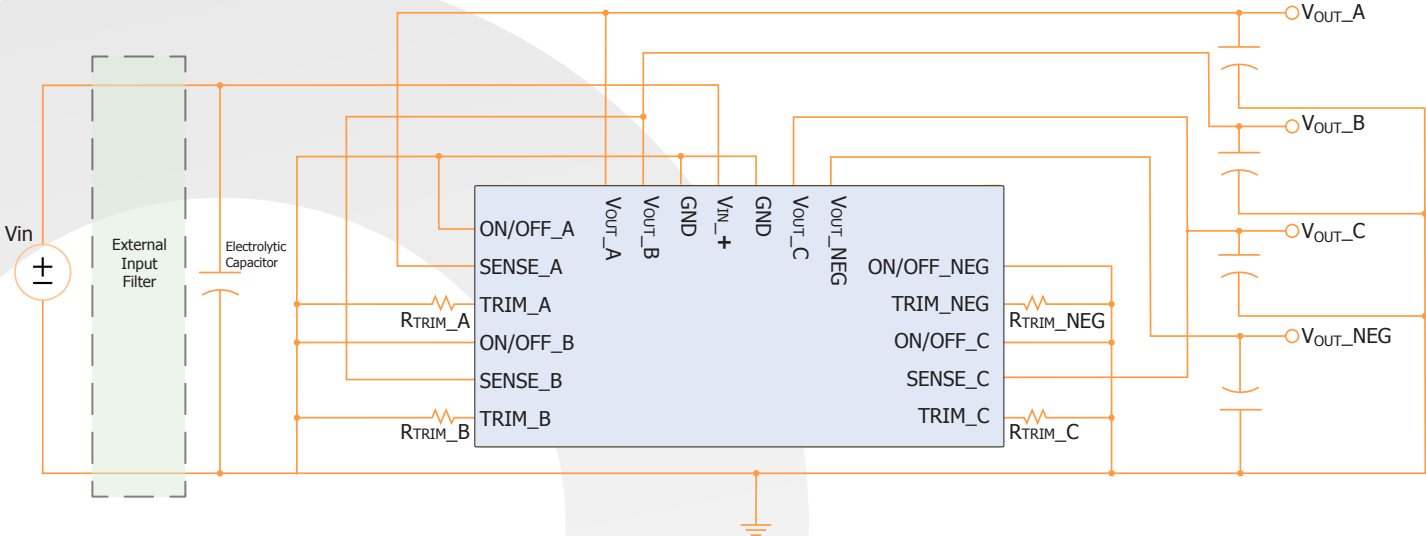

Technical Specification

MCOTS-N-12-Q3P1N-QT ELECTRICAL CHARACTERISTICS

Ta = 25 °C, Vin = 12Vdc unless otherwise noted; full operating temperature range is -55 °C to +100 °C baseplate temperature with appropriate power derating. Specifications subject to change without notice.

Parameter	Vout	Min.	Typ.	Max.	Units	Notes & Conditions
ABSOLUTE MAXIMUM RATINGS						
Input Voltage						
Non-Operating	All	0		16	V	Continuous
Operating	All			15	V	Continuous
Operating Temperature	All	-55		100	°C	Baseplate temperature
Storage Temperature	All	-65		135	°C	
Voltage at ON/OFF input pin	Pos	-3		15	V	Main positive outputs
"	Neg	0		6	V	Auxiliary negative output
RECOMMENDED OPERATING CONDITIONS						
Input Voltage Range	All	6		15	V	Continuous
External Input Capacitance	All	100			µF	ESR < 1.5Ω
Output Voltage	Pos	0.8		5.0	V	Main positive outputs
"	Neg	-13.5		-3.0	V	Auxiliary negative output
Output Current	Pos	0		30	A	Each main positive output
"	Neg	0		1	A	Auxiliary negative output
INPUT CHARACTERISTICS						
Input Under-Voltage Lockout						
Turn-On Voltage Threshold	Pos	5.20	5.60	6.00	V	Main positive outputs
Turn-Off Voltage Threshold	Pos	4.60	5.00	5.40	V	"
Lockout Hysteresis	Pos		0.6		V	"
Turn-On Voltage Threshold	Neg	5.60	5.80	6.00	V	Auxiliary negative output
Turn-Off Voltage Threshold	Neg			2.60	V	Turn-off threshold for negative output varies based on setpoint
Maximum Input Current Limit	1.8V			10	A	Single output, 6Vin, 100% load
"	3.3V			18	A	"
"	5.0V			28	A	"
No-Load Input Current	1.8V		102		mA	Single output, 12Vin
"	3.3V		156		mA	"
"	5.0V		234		mA	"
Disabled Input Current			16		mA	
Input Reflected-Ripple Current	1.0V		36		mA	Single output, 12Vin, 100% load, pk-pk value
"	2.5V		68		mA	"
"	5.0V		98		mA	"
POSITIVE OUTPUT CHARACTERISTICS						
Output Voltage Set Point	0.8V	0.79	0.80	0.81	V	12Vin 50% load
Output Voltage Range		0.8		5.0	V	Main positive outputs
Operating Output Current Range		0		30	A	"
Output Voltage Regulation						
Over Line				0.5	%	Main positive outputs, with sense pin
Over Load				0.6	%	"
Over Temperature				1	%	"
Toal Output Voltage Range				3	%	With sense pin, over sample, line, load, temp. & life
Output Voltage Ripple and Noise (pk-pk\RMS)	1.0V		27\5.0		mV	Full load; 20MHz bandwidth
"	2.5V		43\11.6		mV	"
"	5.0V		67\20.4		mV	"
Output DC Over Current Shutdown			40		A	100°C baseplate temperature
External Output Capacitance		100		10,000	µF	ESR > 1 mΩ
Input Voltage Ripple Rejection			50		dB	120Hz
NEGATIVE OUTPUT CHARACTERISTICS						
Output Voltage Range		-13.5		-3.0	V	
Operating Output Current Range		0		1	A	
Output DC Over Current limit			1.8		A	
External Output Capacitance		100		10,000	µF	ESR > 1 mΩ

Technical Specification

MCOTS-N-12-Q3P1N-QT ELECTRICAL CHARACTERISTICS (continued)

Ta = 25 °C, Vin = 12Vdc unless otherwise noted; full operating temperature range is -55 °C to +100 °C baseplate temperature with appropriate power derating. Specifications subject to change without notice.

Parameter	Vout	Min.	Typ.	Max.	Units	Notes & Conditions
TEMP LIMITS FOR POWER DERATING						
Semiconductor Junction Temperature	All			125	°C	Package rated to 150 °C
Board Temperature	All			125	°C	UL rated max operating temp 130 °C
Baseplate Temperature	All			100	°C	
FEATURE CHARACTERISTICS						
Switching Frequency	Pos	330	360	390	kHz	
"	Neg	215	225	235	kHz	
ON/OFF Control						
Negative Logic (N) ON/OFF Control						
Off-State Voltage	Pos	1.5		6.5	V	
On-State Voltage	Pos	-3.0		0.6	V	
Pull-Up Voltage	Pos		Vin		V	
Pull-Up Resitance	Pos		49.9		kΩ	
Off-State Voltage	Neg	2.4		6.0	V	
On-State Voltage	Neg	0.0		0.6	V	
Output Voltage Trim	Pos	0.8		5.0	V	Measured output pin to ground pin
"	Neg	-13.5		-3.0	V	"
Output Over-Voltage Protection	Pos	5.6	6.0	6.4	V	Main positive outputs, over full temp range
Over-Temperature Shutdown	All		130		°C	Average PCB Temperature
Over-Temperature Shutdown Restart Hysteresis	All		10		°C	
RELIABILITY CHARACTERISTICS						
Calculated MTBF per MIL-HDBK-217F	All		4.5		10 ⁶ Hrs.	Ground Benign, 70°C Tb
Calculated MTBF per MIL-HDBK-217F	All		0.7		10 ⁶ Hrs.	Ground Mobile, 70°C Tb
Field Demonstrated MTBF	All				10 ⁶ Hrs.	See our website for details
DYNAMIC CHARACTERISTICS						
Input Voltage Ripple Rejection	Pos		50		dB	120Hz
Output Voltage during Current Transient						
For a Step Change in Output Current (0.1A/us)	Pos		250		mV	50%-75%-50% Iout max; 100uF
For a Step Change in Output Current (3A/us)	Pos		250		mV	50%-75%-50% Iout max; 470uF
Settling Time	Pos		100		µs	To within 1.5% Vout nom.
Turn on Transient						
Inhibit Time	Pos	2		4	ms	Resistive load
Rise Time	Pos	4		8	ms	"
Output Voltage Overshoot	Pos			0	V	"
EFFICIENCY						
100% Load	1.8V		85		%	Main positive outputs
"	3.3V		90		%	"
"	5.0V		93		%	"
"	-12V		82		%	Auxiliary negative output
50% Load	1.8V		86		%	Main positive outputs
"	3.3V		91		%	"
"	5.0V		93		%	"
"	-12V		84		%	Auxiliary negative output

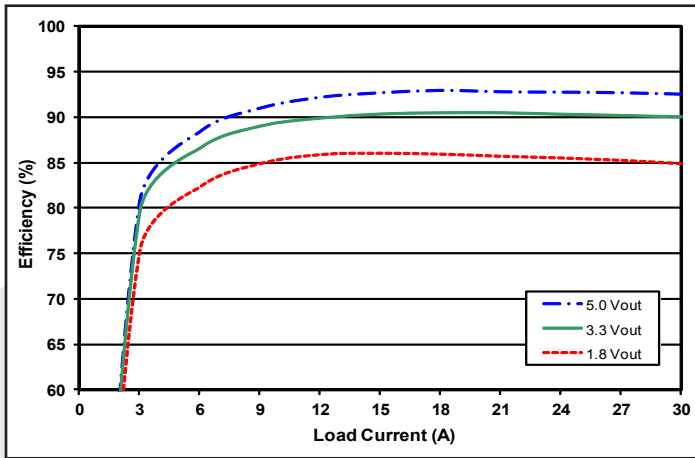

Figure 1: Efficiency at nominal positive output voltage vs. load current for nominal input voltage at 25°C.

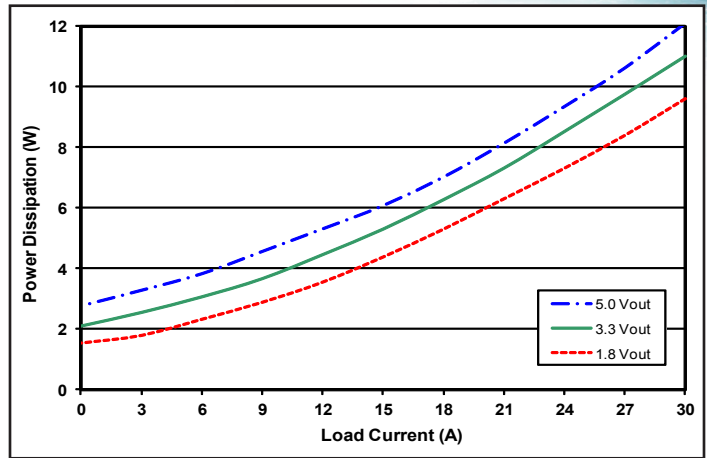

Figure 2: Power dissipation at positive output voltage vs. load current for nominal input voltage at 25°C.

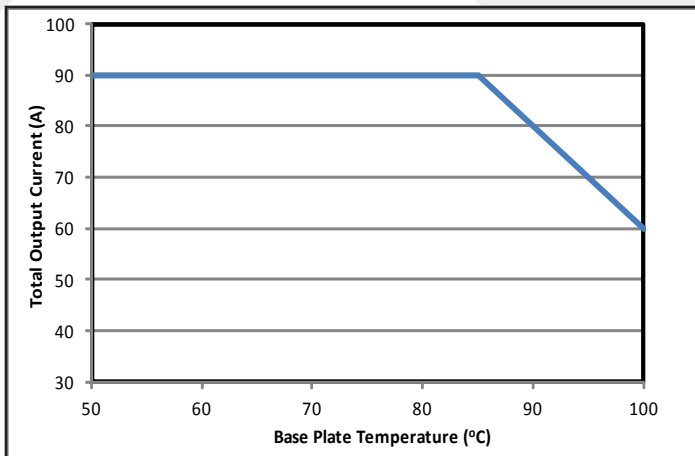

Figure 3: Thermal Derating (maximum total main output current vs. base plate temperature) at nominal input voltage.

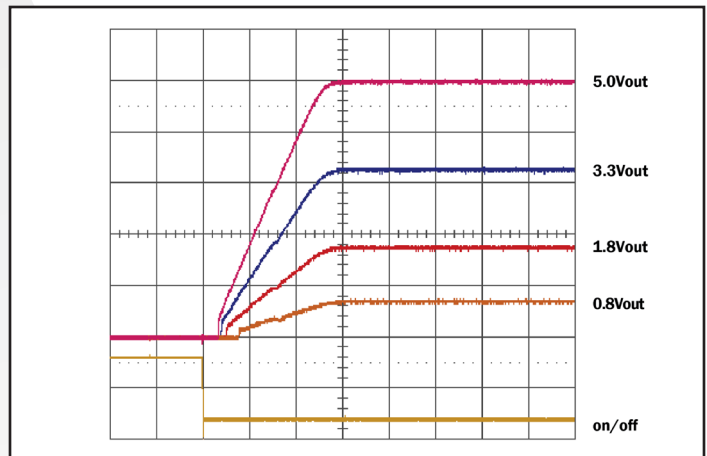

Figure 4: Turn-on transient at full load (resistive load) (2 ms/div).
Ch 1: ON/OFF input (5V/div), Ch 2-5: Vout (1V/div)

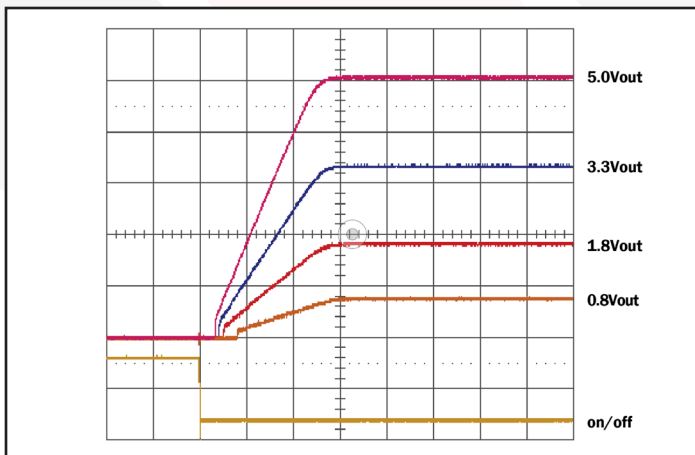

Figure 5: Turn-on transient at zero load (2 ms/div).
Ch 1: ON/OFF input (5V/div), Ch 2-5: Vout (1V/div)

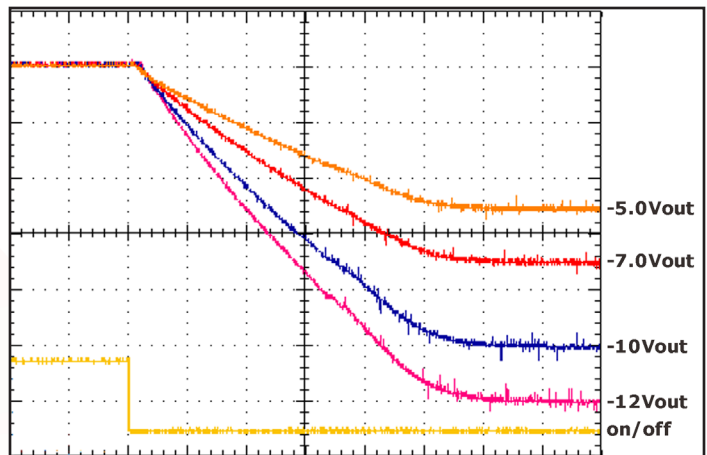

Figure 6: Turn-on transient at full load (resistive load) (10 ms/div).
Ch 1: ON/OFF input (2V/div), Ch 2-5: Vout (2V/div)

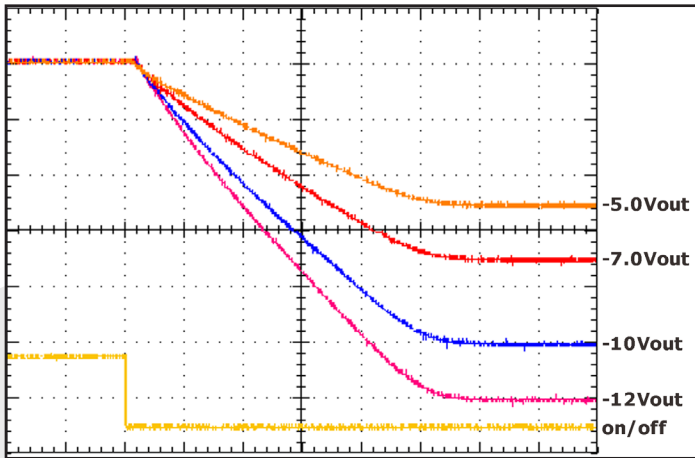

Figure 7: Turn-on transient at zero load (resistive load) (10 ms/div).
Ch 1: ON/OFF input (2V/div), Ch 2-5: Vout (2V/div)

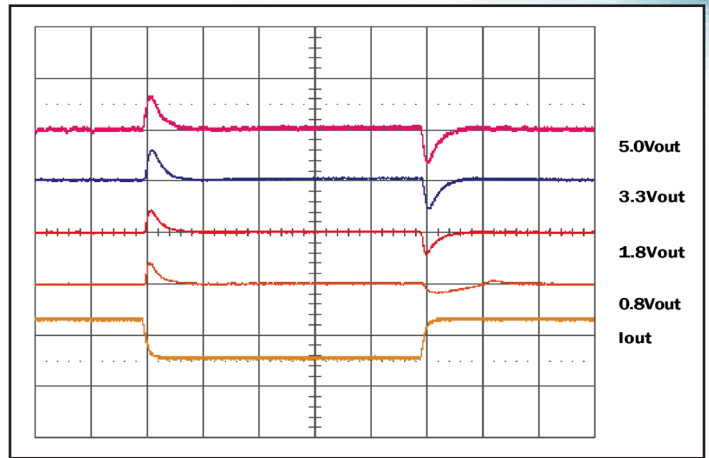

Figure 8: Output voltage response for 0.8V, 1.8V, 3.3V, 5.0V units to step-change in load current (50-75-50% of Iout max; di/dt=0.1A/μs). Load cap: 100 μF, 100mΩ ESR tant, 22 μF cer. Ch 1: Iout (10A/div), Ch 2-5: Vout (500mV/div), 200μs/div.

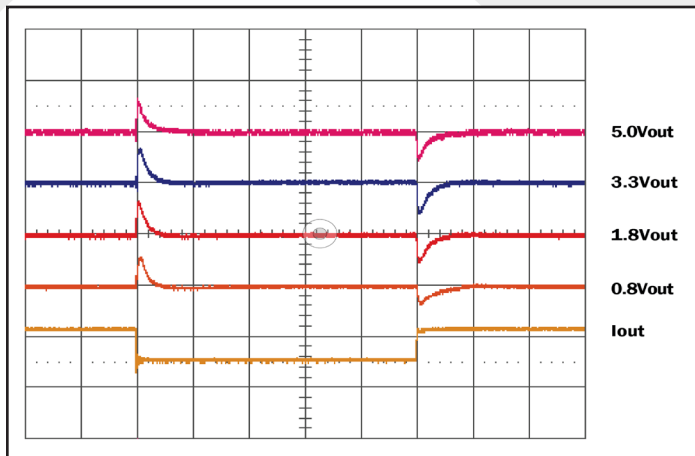

Figure 9: Output voltage response for 0.8V, 1.8V, 3.3V, 5.0V units to step-change in load current (50-75-50% of Iout max; di/dt=3A/μs). Load cap: 100 μF, 100mΩ ESR tant, 22 μF cer. Ch 1: Iout (10A/div), Ch 2-5: Vout (500mV/div), 200μs/div.

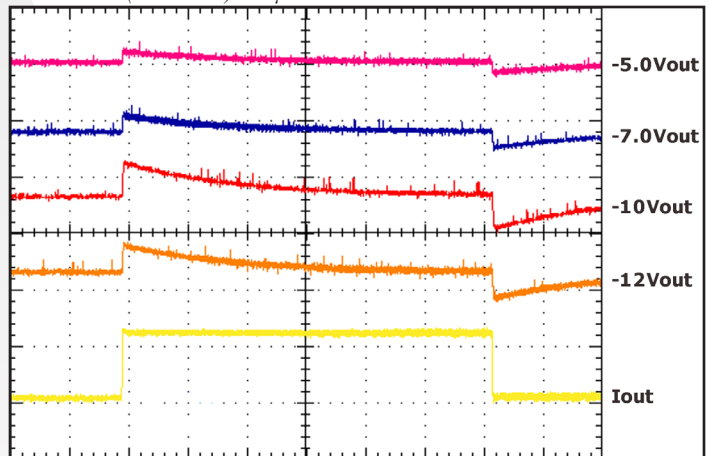

Figure 10: Output voltage response for -12V, -10V, -7V, -5V units to step-change in load current (50-75-50% of Iout max; di/dt=1A/μs). Load cap: 100 μF, 100mΩ ESR tant, 22 μF cer. Ch 1: Iout (0.2A/div), Ch 2-5: Vout (1V/div), 2ms/div.

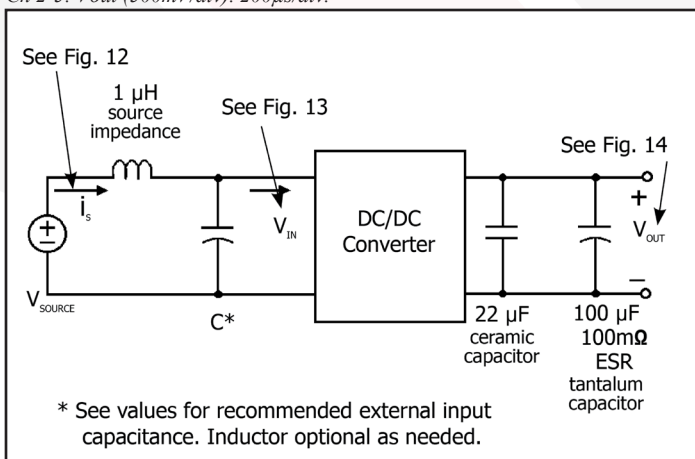

Figure 11: Test set-up diagram showing measurement points for Input Reflected Ripple Current (Figure 12), Input Terminal Ripple Voltage (Figure 13), and Output Voltage Ripple (Figure 14).

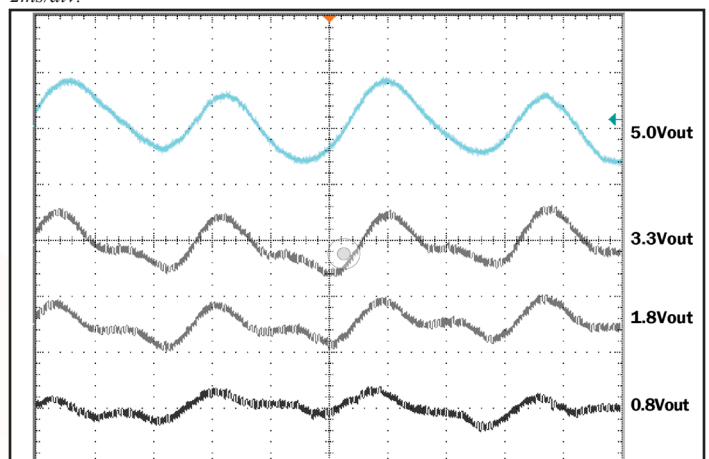

Figure 12: Input Reflected Ripple Current, i_s , through a 1 μH source inductor at nominal input voltage and rated load current (50 mA/div). See Figure 11. 1 μs/div.

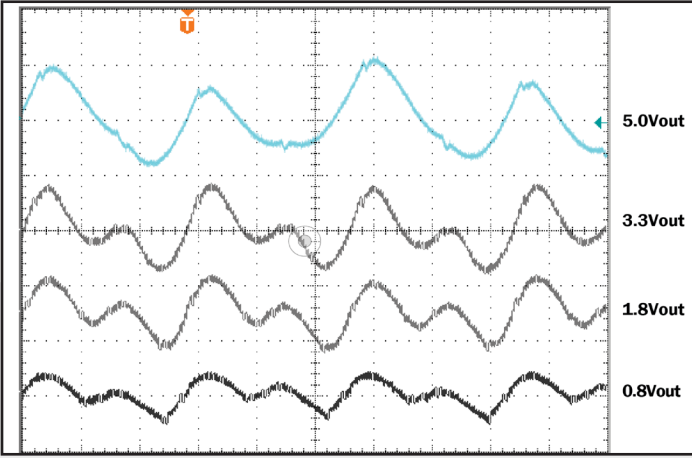

Figure 13: Input Terminal Ripple Voltage at nominal input voltage and rated load current (200 mV/div). Load capacitance: 22 μ F ceramic cap and 100 μ F tantalum cap. Bandwidth: 20 MHz. See Figure 11. 1 μ s/div.

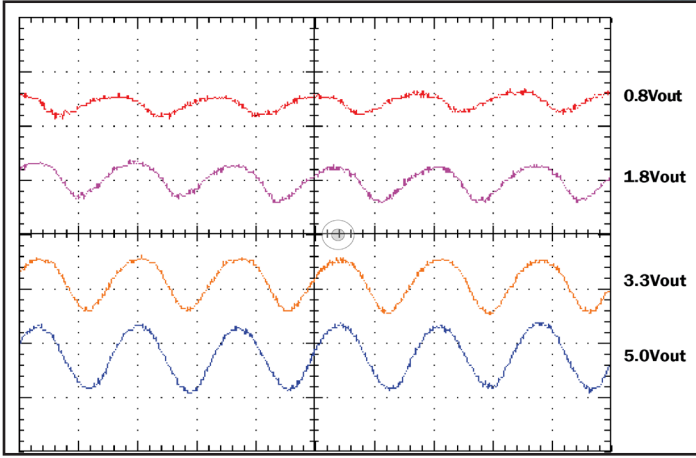

Figure 14: Output Voltage Ripple at nominal input voltage and rated load current (50 mV/div). Load capacitance: 22 μ F ceramic cap and 100 μ F tantalum cap.. Bandwidth: 20 MHz. See Figure 11. 1 μ s/div.

STANDARDS COMPLIANCE

Parameter

STANDARDS COMPLIANCE

- UL 60950-1:2007/R:2011-12
- CAN/CSA C22.2 No. 60950-1:2007/A1:2011
- EN 60950-1:2006/A2:2013

Notes & Conditions

Basic Insulation

Note: An external input fuse must always be used to meet these safety requirements. Contact SynQor for official safety certificates on new releases or download from the SynQor website.



BASIC OPERATION AND FEATURES

The MCOTS-N QUAD Output non-isolated dc-dc converter generates three positive output voltages and one negative output voltage. The output voltage is kept constant over variations in line, load, and temperature. The modules employ synchronous rectification for very high efficiency. The converter runs at a fixed frequency with a predictable EMI performance.

These converters are offered totally encased to withstand harsh environments and thermally demanding applications. Dissipation throughout the converter is so low that it does not require a heatsink for operation in many applications; however, adding a heatsink provides improved thermal derating performance in extreme situations.

CONTROL FEATURES

REMOTE ON/OFF: The ON/OFF input permits the user to control when the converter is on or off. The ON/OFF signal is active low (meaning that a low turns the converter on). Figure A details four possible circuits for driving the ON/OFF pin.

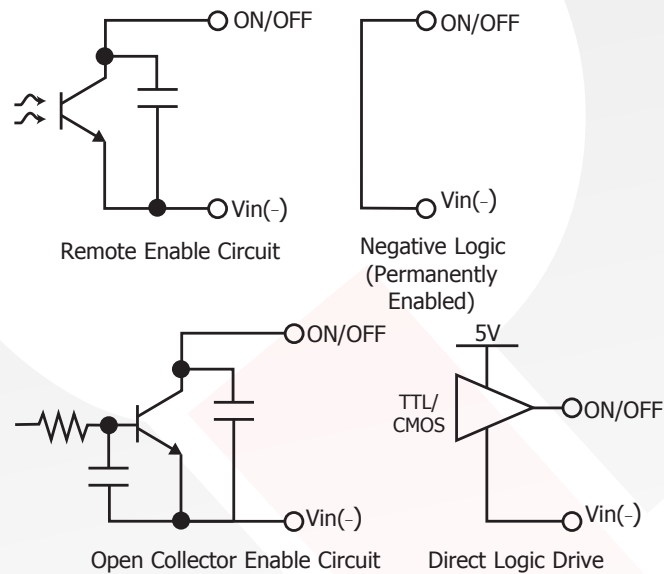

Figure A: Various circuits for driving the ON/OFF pin.

REMOTE SENSE+: The SENSE+ inputs are available for main positive outputs and they correct for voltage drops along the conductors that connect the converter's output pins to the load. The SENSE+ pins should be connected to respective VOUT+ at the point on the board where regulation is desired. SENSE+ pins must be connected for proper regulation of the output voltage. If these connections are not made, the converter will deliver an output voltage that is slightly higher than its specified value.

OUTPUT VOLTAGE TRIM: The TRIM input permits the user to adjust the output voltage according to the trim range specifications by using an external resistor.

For positive outputs: To increase the output voltage from the nominal setpoint of 0.8V using an external resistor, connect the resistor R_{trim_pos} between the TRIM and the Ground pin. For a desired increase of the nominal output voltage, the value of the resistor should be:

$$R_{trim_pos} = \frac{1200}{V_{pos} - 0.8} - 100 \text{ (}\Omega\text{)}$$

$$V_{pos} = 0.8 + \frac{1200}{R_{trim_pos} \text{ (}\Omega\text{)} + 100} \text{ (V)}$$

For negative output: To increase the output voltage from the nominal setpoint of -13.475V using an external resistor, connect the resistor R_{trim_neg} between the TRIM and the Ground pin. For a desired increase of the nominal output voltage, the value of the resistor should be:

$$R_{trim_neg} = \frac{-100 V_{neg} - 122.5}{V_{neg} + 13.475} \text{ (k}\Omega\text{)}$$

$$V_{neg} = - \frac{13.475 R_{trim_neg} \text{ (k}\Omega\text{)} + 122.5}{R_{trim_neg} + 100} \text{ (V)}$$

where V_{neg} is a negative number

To maintain the accuracy of the output voltage over load current, it is vital that any trim resistor be terminated directly to the converter's Ground pin, not at the connection to the load. We do not recommend bypassing the trim pin directly to ground with a capacitor. The voltage gain from the trim pin to output is rather large, 15:1. Ground bounce through a bypass capacitor could introduce significant noise to the converter's control circuit.

PROTECTION FEATURES

Input Under-Voltage Lockout: For positive outputs the converter is designed to turn off when the input voltage is too low, helping avoid an input system instability problem, described in more detail in the application note titled "Input System Instability". The lockout circuitry is a comparator with DC hysteresis. When the input voltage is rising, it must exceed the typical Turn-On Voltage Threshold value (listed on the specification page) before the converter will turn on. Once the converter is on, the input voltage must fall below the typical Turn-Off Voltage Threshold value before the converter will turn off.

Output Current Limiting: To provide protection in an output over load fault condition, the unit is equipped with internal over-current protection. For positive outputs, when the over-current protection is triggered, the unit enters hiccup mode. The units operate normally once the fault condition is removed. For negative output, the output voltage decreases to support load current.

Note: The maximum load current negative output can deliver varies with input and output voltage. The nominal max load current, I_{max_nom} , is 1A, when $V_{in} \geq |V_{neg}|$. When $V_{in} < |V_{neg}|$, the maximum load current is:

$$I_{max} = I_{max_nom} \times \frac{2V_{in}}{V_{in} + |V_{neg}|}$$

Internal Over-Voltage Protection: To fully protect from excessive output voltage, this series contains an Output Over-Voltage Shutdown circuitry. The OVP function is for main positive outputs only. This OVP is independent of the trimmed setpoint. As such, the converter's load is protected from faults in the external trim circuitry (such as a trim pin shorted to ground). Since the setpoint of this OVP does not track trim, it is set at 6.0V. For more detailed information contact SynQor technical support.

Over-Temperature Shutdown: Temperature sensors on the converters sense the average temperature of the module. The thermal shutdown circuit is designed to turn the converter off when the temperature at the sensed location reaches the Over-Temperature Shutdown value. It will allow the converter to turn on again when the temperature of the sensed location falls by the amount of the Over-Temperature Shutdown Restart Hysteresis value.

APPLICATION CONSIDERATIONS

Input Filtering/Capacitance/Damping: The filter circuit of Figure B is often added to the converter's input to prevent switching noise from reaching the input voltage bus.

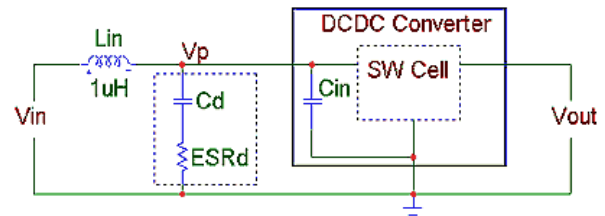

Figure B: Converter with Input Filter.

With L_{in} of $1\mu H$, C_d should be $100\text{-}200\mu F$ and R_d should be $0.1\text{-}0.2\Omega$, in most applications. For more information on designing the input filter and choosing proper values, contact SynQor technical support.

Adding significant external pure ceramic capacitance directly across the converter's input pins is not recommended. Parasitic inductance associated with the input pin geometry and PCB traces can create a high-Q C-L-C circuit with any external capacitors. Just a few nano-Henries of parasitic inductance can create a resonance (or an overtone) near the converter's switching frequency. To avoid this high-frequency resonance, any external input filter should exhibit a net source impedance of at least $20m\Omega$ resistive through this frequency range. This requirement is easily met with the damping elements discussed above. Adding a small amount (a few μF) of high-frequency external ceramic will not violate it. If using converters at higher powers, consider the ripple current rating of C_d . Contact SynQor technical support for details.

Output Capacitance: It is recommended to add at least $100\mu F$ of capacitance, with an ESR in the 0.1Ω range, to the output of the converters. In many applications, however, additional external output capacitance is required to reduce the response to load transients to an allowable level. For minimal overshoot upon recovery, C_d should be related to the minimum in-circuit net ESR. For more detailed derivations of these values contact SynQor technical support.

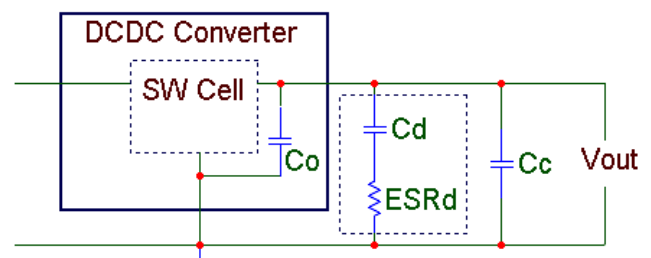

Figure C: Converter with Additional Output Capacitance.



SynQor®

Application Section

MCOTS-N-12-Q3P1N-QT Quad Output Quarter-Brick

Thermal Consideration: The maximum operating baseplate temperature, $T_{B\max}$, is 100 °C. Refer to the Thermal Derating Curves in the Technical Figures section to see the available output current at baseplate temperatures below 100 °C.

$$P_{\text{diss}}^{\text{max}} = \frac{T_B - T_A}{R_{\text{TH}_{BA}}}$$

A power derating curve can be calculated for any heatsink that is attached to the base-plate of the converter. It is only necessary to determine the thermal resistance, $R_{\text{TH}_{BA}}$, of the chosen heatsink between the baseplate and the ambient air for a given airflow rate. This information is usually available from the heatsink vendor. The following formula can be used to determine the maximum power the converter can dissipate for a given thermal condition if its base-plate is to be no higher than 100 °C.

This value of maximum power dissipation can then be used in conjunction with the data shown in the Power Dissipation Curves in the Technical Figures section to determine the maximum load current (and power) that the converter can deliver in the given thermal condition. For convenience, Thermal Derating Curves are provided in the Technical Figures section.

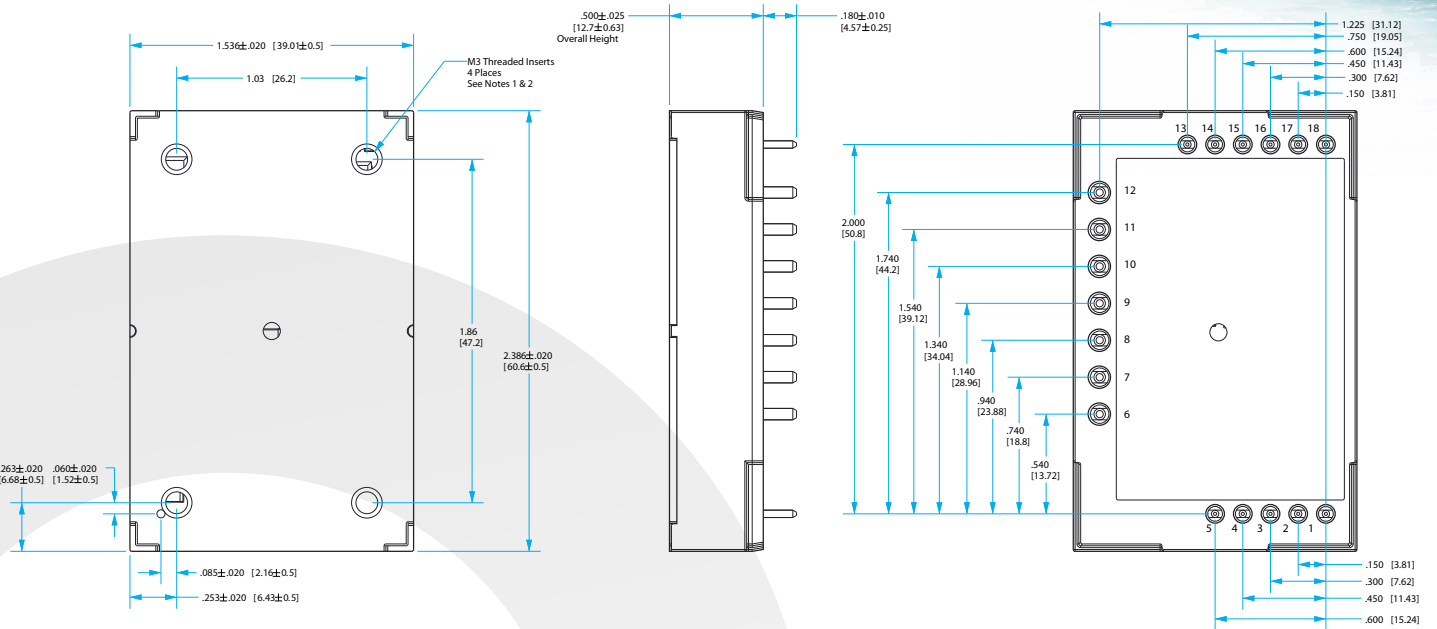

NOTES:

- 1 APPLIED TORQUE PER M3 SCREW SHOULD NOT EXCEED 6in-lb (0.7 Nm). SCREW SHOULD NOT EXCEED 0.100" (2.54mm) DEPTH BELOW THE SURFACE OF THE BASEPLATE.
- 2 BASEPLATE FLATNESS TOLERANCE IS 0.004" (.10mm) TIR FOR SURFACE.
- 3 PINS 1-5 AND 13-18 ARE 0.040" (1.02mm) DIA. WITH .080 (2.03mm) DIA. STANDOFF SHOULDERS.
- 4 PINS 6-12 ARE 0.062" (1.57mm) DIA. WITH 0.100" (2.54mm) DIA. STANDOFF SHOULDERS.
- 5 ALL PINS: MATERIAL: COPPERS ALLOY
FINISH: MATTE TIN OVER NICKEL PLATE
- 6 ALTERNATIVE PIN LENGTH MAYBE AVAILABLE. CHECK WITH FACTORY.
- 7 WEIGHT: 3.27oz. (93g)
- 8 ALL DIMENSIONS IN INCHES(mm)
TOLERANCES: X.XXin +/- 0.02 (X.Xmm +/- 0.5mm)
X.XXXin +/- 0.010 (X.XXmm +/- 0.25mm)

PIN DESIGNATIONS

Pin	Label	Function
1	TRIM_C	Trim for output C
2	SENSE_C	Positive remote sense for output C
3	ON/OFF_C	TTL input to turn converter on and off, referenced to ground, with internal pull up for output C
4	TRIM_NEG	Trim for negative output
5	ON/OFF_NEG	TTL input to turn converter on and off, referenced to ground, with internal pull up for negative output
6	VOUT_NEG	Negative output voltage
7	VOUT_C	Positive output voltage C
8	GND	Ground
9	Vin(+)	Positive input voltage
10	GND	Ground
11	VOUT_B	Positive output voltage B
12	VOUT_A	Positive output voltage A
13	ON/OFF_A	TTL input to turn converter on and off, referenced to ground, with internal pull up for output A
14	SENSE_A	Positive remote sense for output A
15	TRIM_A	Trim for output A
16	ON/OFF_B	TTL input to turn converter on and off, referenced to ground, with internal pull up for output B
17	SENSE_B	Positive remote sense for output B
18	TRIM_B	Trim for output B



Encased Mechanical with Flange

MCOTS-N-12-Q3P1N-QT Quad Output Quarter-Brick

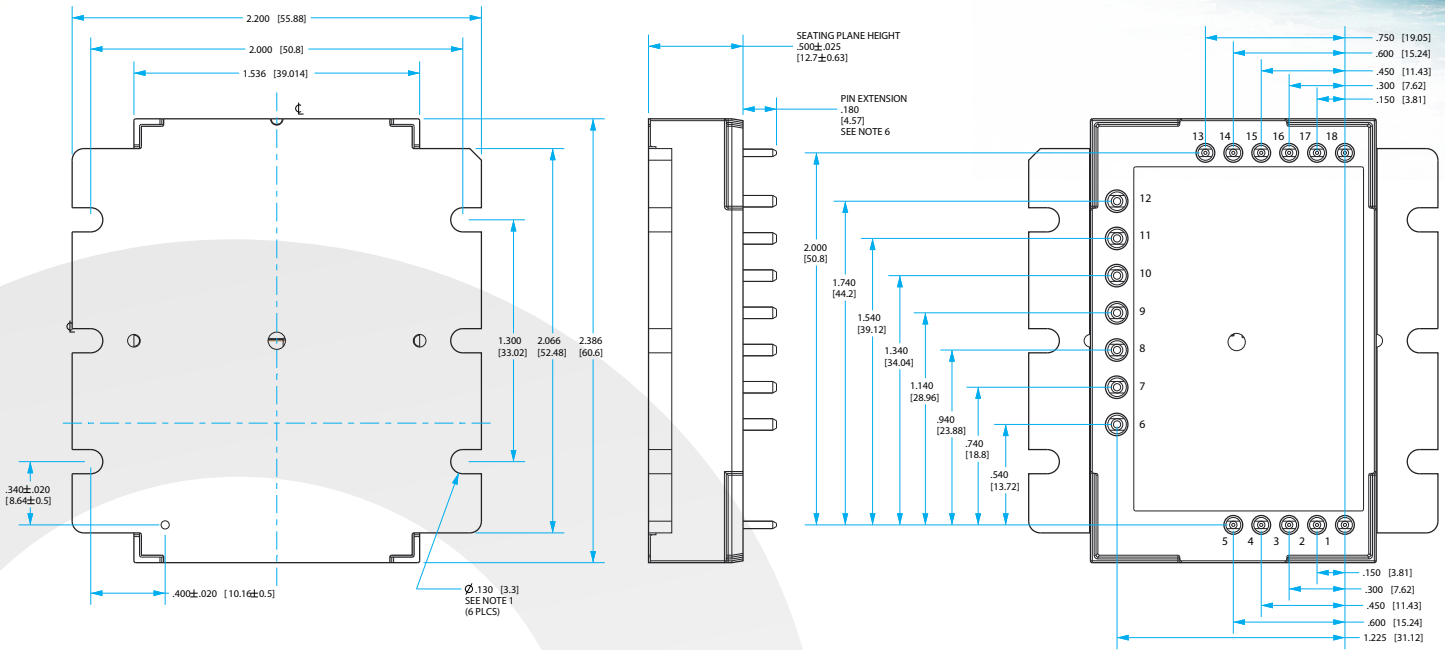

NOTES:

- 1 APPLIED TORQUE PER M3 OR 4-40 SCREW SHOULD NOT EXCEED 6in-lb (0.7 Nm).
- 2 BASEPLATE FLATNESS TOLERANCE IS 0.010" (.25mm) TIR FOR SURFACE.
- 3 PINS 1-5 AND 13-18 ARE 0.040" (1.02mm) DIA. WITH .080 (2.03mm) DIA. STANDOFFS.
- 4 PINS 6-12 ARE 0.062" (1.57mm) DIA. WITH 0.100" (2.54mm) DIA. STANDOFFS.
- 5 ALL PINS: MATERIAL: COPPERS ALLOY
FINISH: MATTE TIN OVER NICKEL PLATE
- 6 ALTERNATIVE PIN LENGTH MAYBE AVAILABLE. CHECK WITH FACTORY.
- 7 WEIGHT: 3.49oz. (99g)
- 8 ALL DIMENSIONS IN INCHES(mm)
TOLERANCES: X.XXin +/- 0.02 (X.Xmm +/- 0.5mm)
X.XXXin +/- 0.010 (X.XXmm +/- 0.25mm)

PIN DESIGNATIONS

Pin	Label	Function
1	TRIM_C	Trim for output C
2	SENSE_C	Positive remote sense for output C
3	ON/OFF_C	TTL input to turn converter on and off, referenced to ground, with internal pull up for output C
4	TRIM_NEG	Trim for negative output
5	ON/OFF_NEG	TTL input to turn converter on and off, referenced to ground, with internal pull up for negative output
6	VOUT_NEG	Negative output voltage
7	VOUT_C	Positive output voltage C
8	GND	Ground
9	Vin(+)	Positive input voltage
10	GND	Ground
11	VOUT_B	Positive output voltage B
12	VOUT_A	Positive output voltage A
13	ON/OFF_A	TTL input to turn converter on and off, referenced to ground, with internal pull up for output A
14	SENSE_A	Positive remote sense for output A
15	TRIM_A	Trim for output A
16	ON/OFF_B	TTL input to turn converter on and off, referenced to ground, with internal pull up for output B
17	SENSE_B	Positive remote sense for output B
18	TRIM_B	Trim for output B



SynQor®

Qualification & Screening

MCOTS-N-12-Q3P1N-QT

Quad Output Quarter-Brick

Mil-COTS Qualification

Test Name	Details	# Tested (# Failed)	Consistent with MIL-STD-883F Method	Consistent with MIL-STD- 883F Method 5005
Life Testing	Visual, mechanical and electrical testing before, during and after 1000 hour burn-in @ full load	15 (0)	Method 1005.8	
Shock-Vibration	Visual, mechanical and electrical testing before, during and after shock and vibration tests	5 (0)		MIL-STD-202, Methods 201A & 213B
Humidity	+85°C, 95% RH, 1000 hours, 2 minutes on / 6 hours off	8 (0)	Method 1004.7	
Temperature Cycling	500 cycles of -55°C to +100°C (30 minute dwell at each temperature)	10 (0)	Method 1010.8	Condition A
Solderability	15 pins	15 (0)	Method 2003	
DMT	-65°C to +110°C across full line and load specifications in 5°C steps	7 (0)		
Altitude	70,000 feet (21 km), see Note	2 (0)		

Note: A conductive cooling design is generally needed for high altitude applications because of naturally poor convective cooling at rare atmospheres.

Mil-COTS DC-DC Converter and Filter Screening

Screening	Process Description	S-Grade	M-Grade
Baseplate Operating Temperature		-55°C to +100°C	-55°C to +100°C
Storage Temperature		-65°C to +135°C	-65°C to +135°C
Pre-Cap Inspection	IPC-A-610, Class III	•	•
Temperature Cycling	MIL-STD-883F, Method 1010, Condition B, 10 Cycles		•
Final Electrical Test	100%	25°C	-55°C, +25°C, +100°C
Final Visual Inspection	MIL-STD-883F, Method 2009	•	•

Mil-COTS MIL-STD-810G Qualification Testing

MIL-STD-810G Test	Method	Description
Fungus	508.6	Table 508.6-I
Altitude	500.5 - Procedure I	Storage: 70,000 ft / 2 hr duration
	500.5 - Procedure II	Operating: 70,000 ft / 2 hr duration; Ambient Temperature
Rapid Decompression	500.5 - Procedure III	Storage: 8,000 ft to 40,000 ft
Acceleration	513.6 - Procedure II	Operating: 15 g
Salt Fog	509.5	Storage
High Temperature	501.5 - Procedure I	Storage: 135°C / 3 hrs
	501.5 - Procedure II	Operating: 100°C / 3 hrs
Low Temperature	502.5 - Procedure I	Storage: -65°C / 4 hrs
	502.5 - Procedure II	Operating: -55°C / 3 hrs
Temperature Shock	503.5 - Procedure I - C	Storage: -65°C to 135°C; 12 cycles
Rain	506.5 - Procedure I	Wind Blown Rain
Immersion	512.5 - Procedure I	Non-Operating
Humidity	507.5 - Procedure II	Aggravated cycle @ 95% RH (Figure 507.5-7 aggravated temp - humidity cycle, 15 cycles)
Random Vibration	514.6 - Procedure I	10 - 2000 Hz, PSD level of 1.5 g ² /Hz (54.6 grms), duration = 1 hr/axis
Shock	516.6 - Procedure I	20 g peak, 11 ms, Functional Shock (Operating no load) (saw tooth)
	516.6 - Procedure VI	Bench Handling Shock
Sinusoidal vibration	514.6 - Category 14	Rotary wing aircraft - helicopter, 4 hrs/axis, 20 g (sine sweep from 10 - 500 Hz)
Sand and Dust	510.5 - Procedure I	Blowing Dust
	510.5 - Procedure II	Blowing Sand



MCOTS-N-12-Q3P1N-QT
Quad Output
Quarter-Brick

Ordering Information

Ordering Information/ Part Numbering

Not all combinations make valid part numbers, please contact SynQor for availability. See product summary page for details.

Example: MCOTS-N-12-Q3P1N-QT

Family	Product	Input Voltage	Output Voltage	Package	Thermal Design	Screening Level	Options
MCOTS	N: Non-Isolated Converter	12: 6-15V	Quad Output Q3P1N: 3 Positive, 1 Negative	QT: Quarter Brick Tera	N: Normal Threaded F: Flanged	S: S-Grade M: M-Grade	[]: Standard Feature

PART NUMBERING SYSTEM

The part numbering system for SynQor's MCOTS Non-Isolated Quad Converters follow the format shown in the example.

Contact SynQor for further information and to order:

Phone:978-849-0600
 Toll Free:888-567-9596
 Fax:978-849-0602
 E-mail:mqnbofae@synqor.com
 Web:www.synqor.com
 Address:155 Swanson Road
 Boxborough, MA 01719
 USA

APPLICATION NOTES

A variety of application notes and technical white papers can be downloaded in PDF format from our [website](#).

PATENTS

SynQor holds numerous U.S. patents, one or more of which apply to most of its power converter products. Any that apply to the product(s) listed in this document are identified by markings on the product(s) or on internal components of the product(s) in accordance with U.S. patent laws. SynQor's patents include the following:

5,999,417	6,222,742	6,545,890	6,594,159	6,731,520	6,894,468
6,896,526	6,927,987	7,050,309	7,072,190	7,085,146	7,119,524
7,269,034	7,272,021	7,272,023	7,558,083	7,564,702	7,765,687
7,787,261	8,023,290	8,149,597	8,493,751	8,644,027	9,143,042

WARRANTY

SynQor offers a two (2) year limited warranty. Complete warranty information is listed on our website or is available upon request from SynQor.