

### HIGH RELIABILITY EMI FILTER

<b>-400V to +400V</b> Continuous Input	<b>3A</b> Output Current	<b>0.84Ω @ 125°C</b> Max. DC Resistance	<b>&gt;80dB @ 500kHz</b> Differential Attenuation
---	-----------------------------	--	--

**FULL POWER OPERATION: -55°C to +125°C**

The MilQor® series of high-reliability EMI filters brings SynQor's field proven technology and manufacturing expertise to the Military/Aerospace industry. SynQor's innovative QorSeal™ packaging approach ensures survivability in the most hostile environments. Compatible with the industry standard format, these filters have high differential-mode and common-mode attenuation, low DC resistance, and a stabilizing bulk capacitor resistor. They follow conservative component derating guidelines and they are designed and manufactured to comply with a wide range of military standards.

## MilQor®

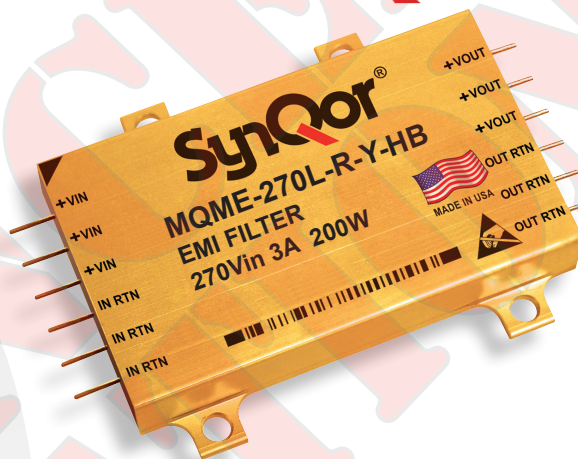

DESIGNED & MANUFACTURED IN THE USA  
FEATURING QORSEAL™ HI-REL ASSEMBLY

#### Design Process

MQME series filters are:

- Designed for reliability per NAVSO-P3641-A guidelines
- Designed with components derated per:
  - MIL-HDBK-1547A
  - NAVSO P-3641A

#### Qualification Process

MQME series filters are qualified to:

- MIL-STD-810F
  - consistent with RTCA/DO-160E/F/G
- SynQor's First Article Qualification
  - consistent with MIL-STD-883F
- SynQor's Long-Term Storage Survivability Qualification
- SynQor's on-going life test

#### In-Line Manufacturing Process

- AS9100 and ISO 9001:2008 certified facility
- Full component traceability
- Temperature cycling
- Constant acceleration
- 24, 96, 160 hour burn-in
- Three level temperature screening

#### Features

- 3A output current
- Reverse polarity protection
- Very low DC resistance
- > 80 dB differential-mode attenuation at 500kHz
- > 60 dB common-mode attenuation at 500kHz
- Stabilizing bulk capacitor and damping resistor included
- All capacitors are X7R multi-layer ceramic
- Designed to meet all MIL-STD 461 EMI and most RTCA/DO-160E/F/G Section 22 lightning requirements

#### Specification Compliance

MQME series filters (with MQFL converters) are designed to meet:

- MIL-HDBK-704-7 (A through F)
- RTCA/DO-160E/F/G Section 16
- MIL-STD-1275B/D
- DEF-STAN 61-5 (part 6)/5
- MIL-STD-461 (C, D, E)
- RTCA/DO-160E/F/G Section 22



**BLOCK DIAGRAM**

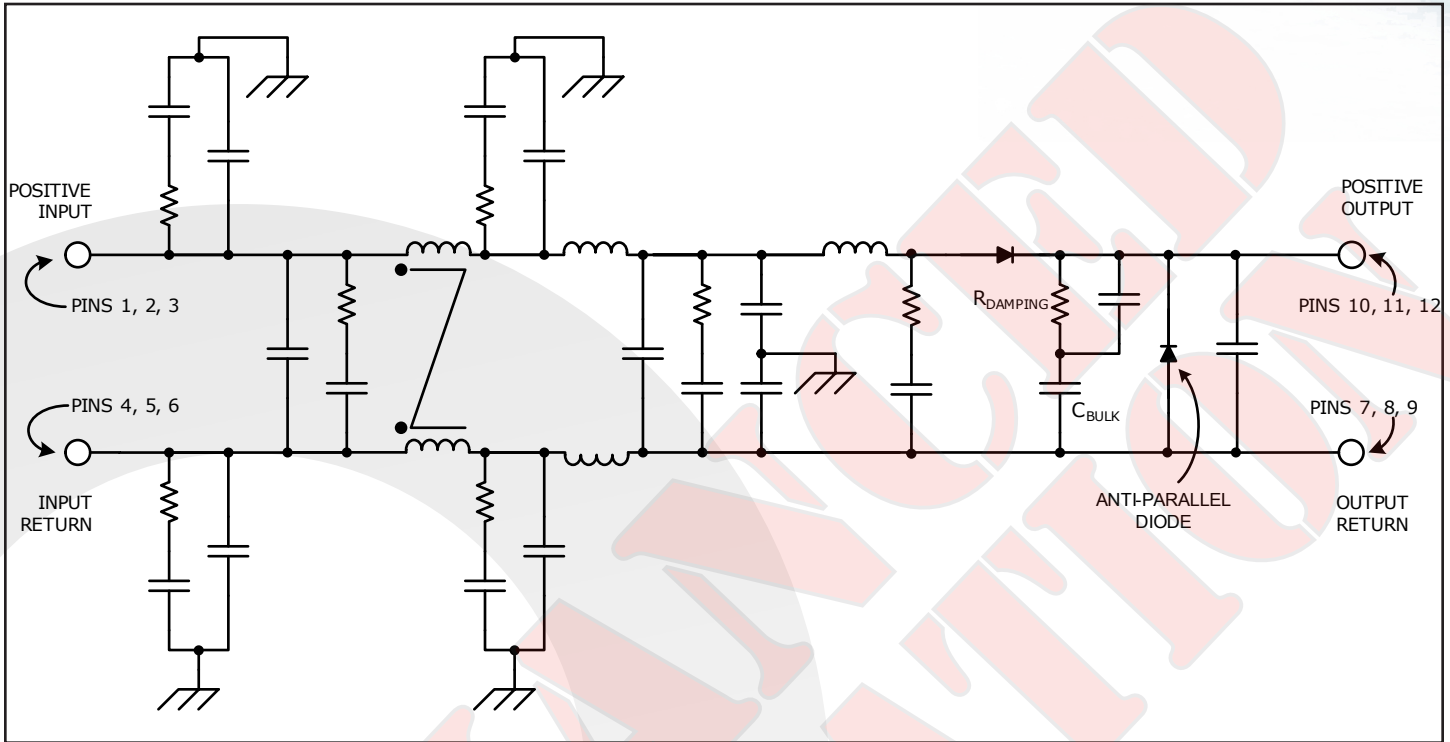

**TYPICAL CONNECTION DIAGRAM**

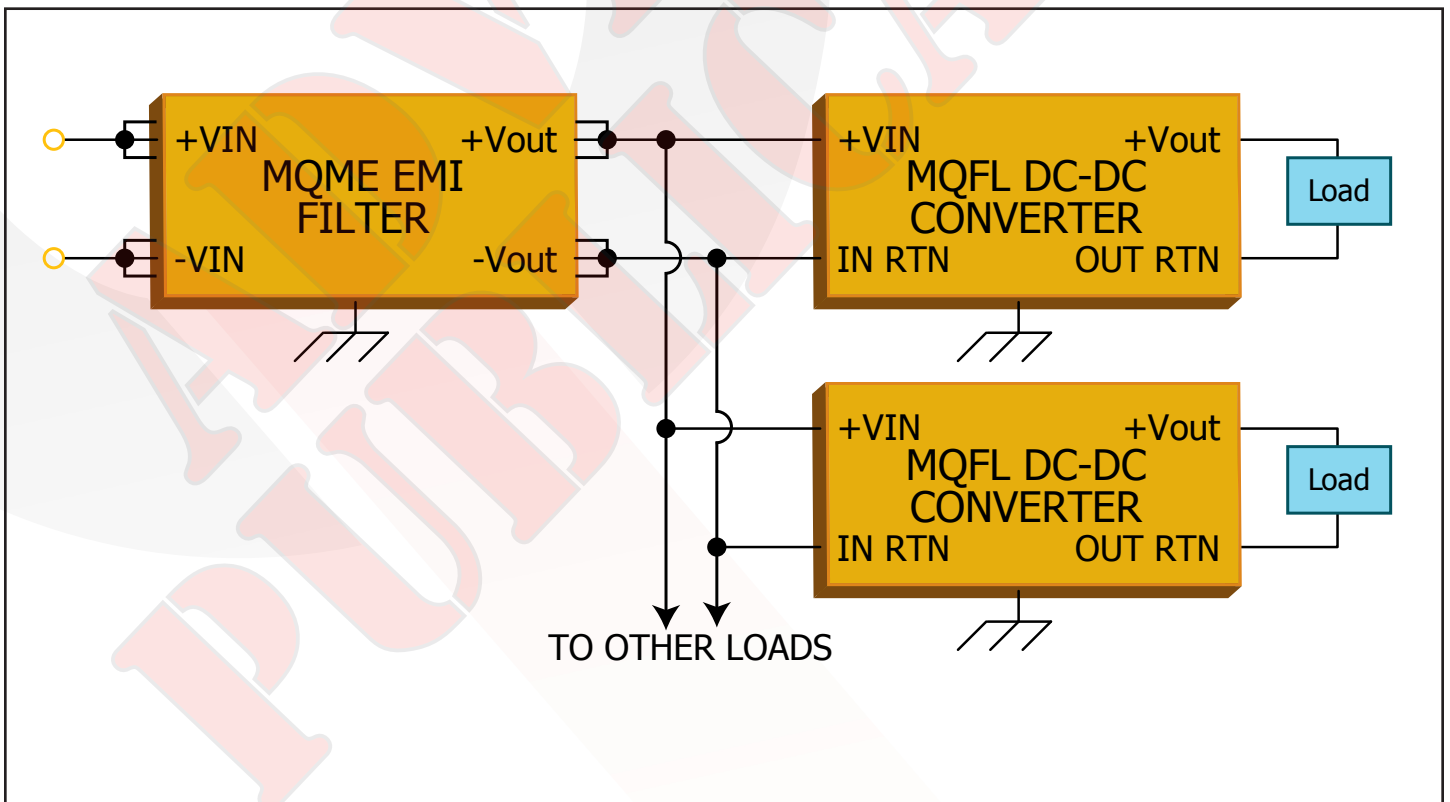



# SynQor®

## Technical Specification

**MQME-270L-R**  
**Current: 3A**

### MQME-270L-R Electrical Characteristics

Parameter	Min.	Typ.	Max.	Units	Notes & Conditions	Group A Subgroup <sup>3</sup>
<b>ABSOLUTE MAXIMUM RATINGS</b> <small>V<sub>in</sub>=270V DC ±5%, P= 200W unless otherwise specified</small>						
Input Voltage					See Note 1	
Continuous	-550		550	V		
Transient (≤1 s)	-550		550	V		
Isolation Voltage (Input/Output to case)						
Continuous	-500		500	V		
Transient (≤1 s)	-1000		1000	V		
Output Current			3	A		
Operating Case Temperature	-55		125	°C	HB Grade Products, See Note 6	
Storage Case Temperature	-65		135	°C		
Lead Temperature (20 s)			300	°C		
<b>ELECTRICAL CHARACTERISTICS</b>						
Input Voltage						
Continuous	-400		400	V	See Note 1 for negative limits	1, 2, 3
Transient (≤1 s, R <sub>s</sub> * = 0 Ω)	-500		500	V	"	
Transient (≤100 ms, R <sub>s</sub> * = 0 Ω)	-500		500	V	See Note 1	
Output Voltage (continuous)	V <sub>out</sub> = V <sub>in</sub> - (I <sub>in</sub> x R <sub>dc</sub> ) - V <sub>d</sub>			V		1, 2, 3
Output Current (continuous)			3	A		1, 2, 3
Power (continuous)			200	W	See Note 5	
DC Resistance (R <sub>dc</sub> )						
TCASE = 25°C			0.63	Ω		1
TCASE = 125°C			0.84	Ω		3
Rectifier Drop (V <sub>d</sub> )		0.8		V		
Power Dissipation (3A output current)						
TCASE = 25°C			5.7	W		1
TCASE = 125°C			7.5	W		3
Anti-Parallel Diode						
Forward Current						
Continuous			0.2	A		1, 2, 3
Transient (≤ 8 ms)			3	A		
Forward Voltage (@ 0.1 A)	0.4		1	V		1, 2, 3
Total Differential-Mode Capacitance		1		μF	Measured across input or output pins	
Total Common-Mode Capacitance		0.47		μF	Measured between any pin to case	
Bulk Capacitor		1.41		μF		
Damping Resistor		4.7		Ω		
Noise Attenuation					See Figure 1	
<b>INPUT VOLTAGE SPIKE SUPPRESSION</b>						
Output Voltage Deviation due to a Spike					See Note 2	
Input Voltage Spike (Centered on V <sub>in</sub> )						
±200V, 10μs, R <sub>s</sub> ≤ 0.5Ω,  Q  ≤ 250μC	-50		150	ΔV	MIL-STD-461C (CS06). See Note 4	
±400V, 5μs, R <sub>s</sub> ≤ 0.5Ω,  Q  ≤ 250μC	-50		150	ΔV	MIL-STD-461C (CS06). See Note 4	
±600V, 10μs, R <sub>s</sub> = 50Ω	-50		150	ΔV	RTCA/DO-160E/F/G	

\* R<sub>s</sub> = Source Impedance



# SynQor®

## Technical Specification

**MQME-270L-R**  
**Current: 3A**

### MQME-270L-R Electrical Characteristics (Continued)

Parameter	Min.	Typ.	Max.	Units	Notes & Conditions	Group A Subgroup <sup>3</sup>
<b>ISOLATION CHARACTERISTICS</b>						
Isolation Voltage (any pin to case)						
Continuous	-500		500	V		1
Transient ( $\leq 100 \mu\text{s}$ )	-800		800	V		
Isolation Resistance (any pin to case)	100			M $\Omega$		1
<b>RELIABILITY CHARACTERISTICS</b>						
Calculated MTBF (MIL-STD-217F2)						
GB @ Tcase = 70°C		TBD		10 <sup>6</sup> Hrs.		
AIF @ Tcase = 70°C		TBD		10 <sup>3</sup> Hrs.		
<b>WEIGHT CHARACTERISTICS</b>						
Device Weight		79		g		

#### Electrical Characteristics Notes

1. While the filter will survive these input voltage limits, the filter's output voltage will be outside the limits for an MQFL converter input voltage range.
2. Verified by qualification testing and analysis.
3. Only the ES and HB grade products are tested at three temperatures. The C grade products are tested at one temperature. Please refer to the Construction and Environmental Stress Screening Options table for details.
4. With an external 2uF capacitor in series with a 5ohm resistor connected across the output of the MQME filter module.
5. Product of input current and output voltage must be less than 200W.
6. The specified operating case temperature for ES grade products is -45°C to 100°C. The specified operating case temperature for C grade products is 0°C to 70°C

\* Rs = Source Impedance



**MQME-270L-R**

**Current: 3A**

## BASIC OPERATION AND FEATURES

The MQME-270L-P is a multi-stage differential-mode and common-mode passive EMI filter designed to interface a power source with one or more SynQor DC/DC converters (or other loads that create EMI). Each stage of this filter is well damped to avoid resonances and oscillations, and only X7R multi-layer ceramic capacitors are used. Figure 1 shows the typical differential and common-mode attenuation provided by this filter when the source impedance is 50W to chassis ground on each input line.

The MQME-270L-P EMI filter includes a large bulk capacitor (also X7R) with a series damping resistor to correct for the unstabilizing effect of a converter's negative input resistance. A white paper discussing this negative input resistance and the need for corrective damping can be found on the SynQor website (see Input System Instability application note). Figure 2 shows the magnitude of the filter's output impedance when the filter input is connected to a stiff voltage source.

When used with SynQor's DC/DC converters, the MQME-270L-P EMI filter is designed to pass all of the relevant MIL-STD-461C/D/E requirements to their most stringent limits. The MIL-STD-461 Compliance Matrix Table lists these requirements and describes the setup used to pass them. Figures 3 - 6 show results from selected conductive and radiated emissions tests.

The filter is also designed to pass the waveform types and applications specified in RTCA/DO-160E/F/G Section 22 (Lightning Induced Transient Susceptibility) to Level 4 (some waveforms / applications require external transient suppression circuitry). The Section 22 Compliance Matrix Table lists these waveforms and applications and describes the setup used to pass them.

A typical application would place the MQME filter close to the input of the DC/DC converter, with the cases of the filter and the converter connected together through a ground plane. Both cases are electrically conductive, so connection to the cases can be made with the fasteners used to secure the device.

Do not connect the outputs of multiple MQME-270L-P filters in parallel. Connecting filters in this manner may result in slightly unequal currents to flow in the positive and return paths of each filter. These unequal currents may cause the internal common-mode chokes to saturate and thus cause degraded common-mode rejection performance.

**REVERSE POLARITY PROTECTION:** The MQME-270L-R EMI filter has a series-connected diode. This diode blocks reverse current flow if the filter's input voltage is mistakenly connected with the wrong polarity. The anti-parallel diode, working with the reverse polarity diode, ensures that the filter's output voltage goes only slightly negative during this time, and therefore satisfying the minimum input voltage specifications of SynQor's MQFL converters.

The reverse polarity diode also performs a useful function during negative polarity spikes and surges, and during brief power interrupts. Since it stops current from flowing negatively through the EMI filter back toward the source, the diode allows the total bulk capacitor (located both within and external to the filter) to better hold up the output voltage during these transients.



**MQME-270L-R**  
**Current: 3A**

**Technical Specification**

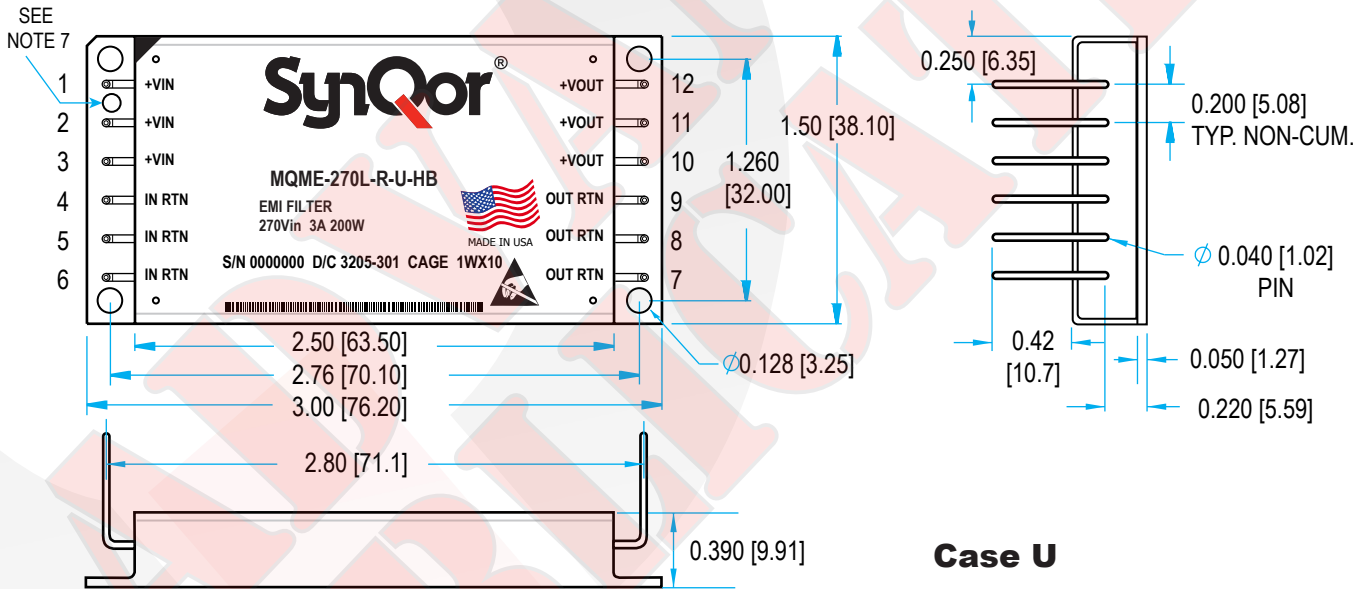
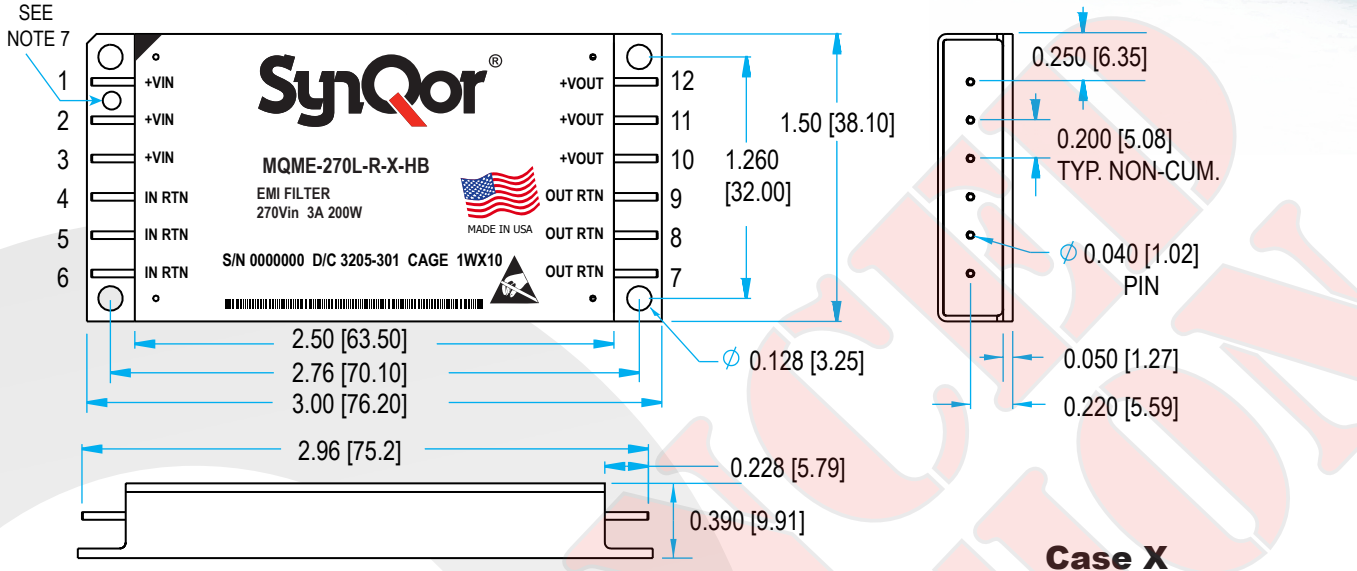

**NOTES**

- 1) Pins 0.040" (1.02mm) diameter
- 2) Pins Material: Copper Alloy  
Finish: Gold over Nickel plating, followed by Sn/Pb solder dip
- 3) All dimensions in inches (mm) Tolerances: x.xx +/-0.02 in. (x.x +/-0.5mm)  
x.xxx +/-0.010 in. (x.xx +/-0.25mm)
- 4) Weight: 2.8 oz (78.5 g) typical
- 5) Workmanship: Meets or exceeds IPC-A-610C Class III
- 6) Print Labeling on Top Surface per Product Label Format Drawing
- 7) Pin 1 identification hole, not intended for mounting (case X and U)

**PIN DESIGNATIONS**

Pin #	Function	Pin #	Function
1	Positive input	7	Output return
2	Positive input	8	Output return
3	Positive input	9	Output return
4	Input return	10	Positive output
5	Input return	11	Positive output
6	Input return	12	Positive output



**MQME-270L-R**  
**Current: 3A**

**Technical Specification**

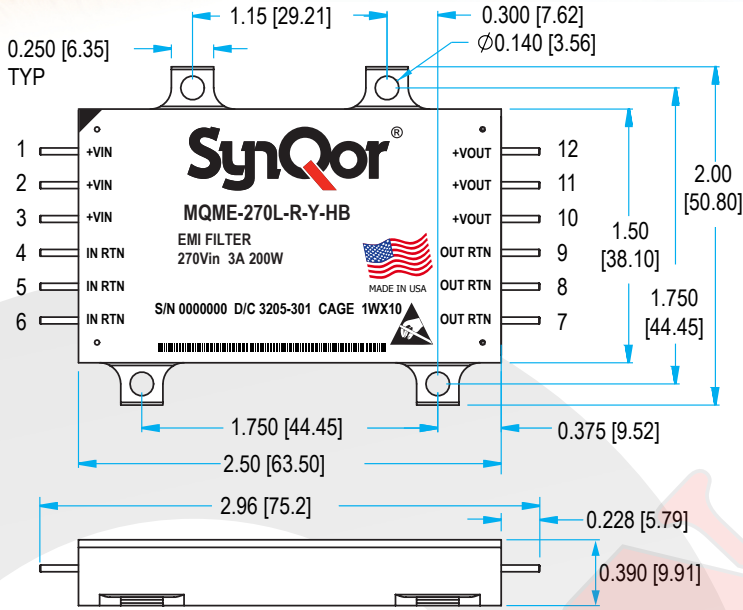

**Case Y**

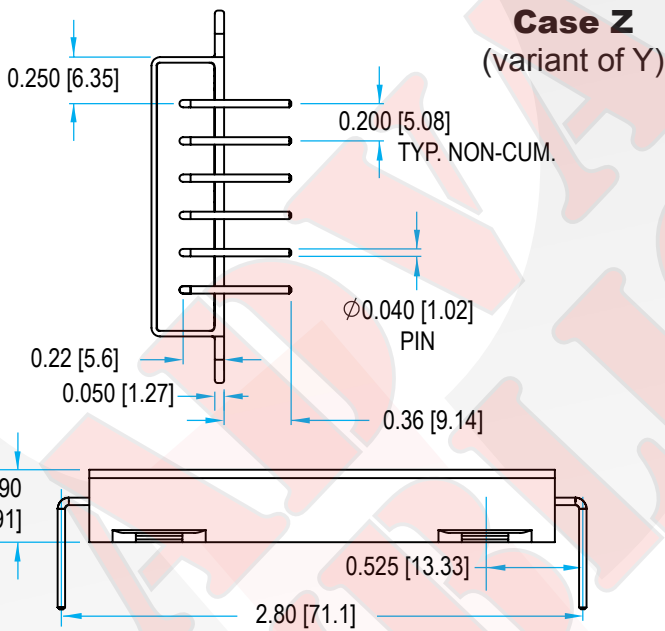

**Case Z**  
(variant of Y)

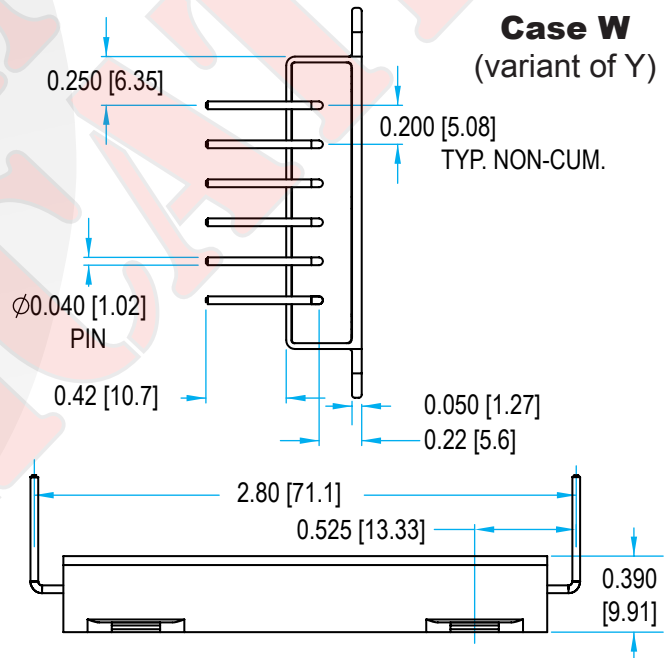

**Case W**  
(variant of Y)

**NOTES**

- 1) Pins 0.040" (1.02mm) diameter
- 2) Pins Material: Copper Alloy  
Finish: Gold over Nickel plating, followed by Sn/Pb solder dip
- 3) All dimensions in inches (mm) Tolerances: x.xx +/-0.02 in. (x.x +/-0.5mm)  
x.xxx +/-0.010 in. (x.xx +/-0.25mm)
- 4) Weight: 2.8 oz (78.5 g) typical
- 5) Workmanship: Meets or exceeds IPC-A-610C Class III
- 6) Print Labeling on Top Surface per Product Label Format Drawing
- 7) Pin 1 identification hole, not intended for mounting (case X and U)

**PIN DESIGNATIONS**

Pin #	Function	Pin #	Function
1	Positive input	7	Output return
2	Positive input	8	Output return
3	Positive input	9	Output return
4	Input return	10	Positive output
5	Input return	11	Positive output
6	Input return	12	Positive output



**MQME-270L-R**  
**Current: 3A**

**Technical Specification**

**Lightning Induced Transient Susceptibility  
 RTCA/DO-160E/F/G Section 22 Compliance Matrix**

This table shows the RTCA/DO-160E/F/G Section 22 requirements/limits that will be met\* by a stand-alone setup comprised of:

RTCA/DO-160E/F/G	RTCA/DO-160E/F/G Section 22		
	Waveform	Maximum Level Passed	Test Conditions
Pin Injection	3	4	Signal applied to +Vin pin. Input Return pin connected to system ground
	4	4†	
	5a	4†	
Single- and Multiple-Stroke Cable Induction	2	4**	Signal applied to unshielded power cable bundle
	3	4	
Single- and Multiple-Stroke Ground Injection	4	4	Signal applied between metal ground plane and system ground
	5	4	
Multiple-Burst Cable Induction	3	4	Signal applied to unshielded power cable bundle

\* Requirement is considered to be met as long as transient deviations in the converter's output voltage remain within  $\pm 10\%$  of its initial value.  
 † For these waveforms at Level 3 and above, an external transient suppressor of sufficient energy rating must be placed across the filter's input pins to keep the differential transient input voltage below +200V/-50V. Negative polarity waveforms may cause power flow to the converter to be interrupted long enough to cause a graceful shutdown and restart of the converter. Also, the reverse voltage protection feature of the -T filter is required to protect the converter (but not the filter) from negative polarity waveform.  
 \*\* For this waveform at a Level 4 and above, external transient suppressors of sufficient energy rating must be added between the filter's input power pins and its case to keep the common-mode transient input voltage below +800V.

Hi-Rel	Will be met by any MQME / MQHE P Filter • MQME-28-P Filter • MQFL-28-05S Converter • 120W Resistive load • Metal Chassis Plane • MQME-270-P Filter • MQFL-270-05S Converter • 120W Resistive load • Metal Chassis Plane
	Will be met by any MQME / MQHE T Filter • MQME-28-T Filter • MQFL-28-05S Converter • 120W Resistive load • Metal Chassis Plane • MQME-270-T Filter • MQFL-270-05S Converter • 120W Resistive load • Metal Chassis Plane





**MQME-270L-R**  
**Current: 3A**

**Technical Specification**

**EMI**  
**Military Standard 461 Compliance Matrix**

This table shows the MIL-STD-461 requirements/limits that will be met\* by the stand-alone setups indicated below:

Mil-Std-461	MIL-STD-461C		Mil-Std-461	MIL-STD-461D/E/F	
	Requirement	Most Stringent Limit Listed		Requirement	Most Stringent Limit Listed
<b>Conducted Emissions</b>	CE01 CE03 CE07	Class A5 (Submarine) Class A5 (Submarine)‡ Class A1 (Aircraft)	<b>Conducted Emissions</b>	CE101 CE102	Submarine Basic Curve
<b>Conducted Susceptibility</b>	CS01 CS02 CS06 CS10 CS11	Class A5 (Submarine) Class A5 (Submarine) Class A1/A5 (Aircraft/Sub) Class A5 (Submarine) Class A5 (Submarine)	<b>Conducted Susceptibility</b>	CS101 CS106 CS114 CS115 CS116	Curve #2 461F Only Curve #5 Basic Waveform Imax = 10A
<b>Radiated Emissions</b>	RE01 RE02†	Class A5 (Submarine) Class A5 (Submarine)	<b>Radiated Emissions</b>	RE101  RE102†	Navy  Submarine Fixed Wing Internal, >25 meters Nose to Tail
<b>Radiated Susceptibility</b>	RS01 RS02 RS03	Class A5 (Submarine) Class A1/A5 (Aircraft/Sub) Class A4 (Surface Ship)	<b>Radiated Susceptibility</b>	RS101 RS103	Army Aircraft External

\* Susceptibility requirements/limits are considered to be met as long as transient deviations in the converter's output voltage remain within ±10% of its initial value.

† Met with metal screen shield covering the filter, converter, and resistive load.

‡ In almost every case the limit listed is the most stringent of the requirements. The one exception is CE03 - High Frequency Broadband Conducted Emissions, Converter with Passive Filter. In this case the filter and converter passed the A1 limit. The filter and converter pass the CE03 - Narrowband Conducted Emissions at the A5 limit level.

<b>Hi-Rel</b>	<ul style="list-style-type: none"> <li>• MQME-28-P (or -T) Filter</li> <li>• MQFL-28-05S Converter</li> <li>• 120W Resistive load</li> <li>• Metal Chassis Plane</li> <li>• MQME-270-P Filter</li> <li>• MQFL-270-05S Converter</li> <li>• 120W Resistive load</li> <li>• Metal Chassis Plane</li> </ul>	<b>MCOTS</b>	<ul style="list-style-type: none"> <li>• MCOTS-F-28-P Filter</li> <li>• MCOTS-28-05S Converter</li> <li>• 120W Resistive load</li> <li>• Metal Chassis Plane</li> <li>• MCOTS-F-270-P Filter</li> <li>• MCOTS-270-05-QT Converter</li> <li>• 120W Resistive load</li> <li>• Metal Chassis Plane</li> </ul>
---------------	--	--------------	--



**MQME-270L-R**  
**Current: 3A**

CONSTRUCTION AND ENVIRONMENTAL STRESS SCREENING OPTIONS				
Screening	Consistent with MIL-STD-883F	C-Grade (specified from 0 °C to +70 °C)	ES-Grade (specified from -45 °C to +100 °C)	HB-Grade (specified from -55 °C to +125 °C)
Element Evaluation		No	Yes	Yes
Internal Visual	*	Yes	Yes	Yes
Temperature Cycle	Method 1010	No	Condition B (-55 °C to +125 °C)	Condition C (-65 °C to +150 °C)
Constant Acceleration	Method 2001 (Y1 Direction)	No	500g	Condition A (5000g)
Burn-in	Method 1015	24 Hrs @ +125 °C	96 Hrs @ +125 °C	160 Hrs @ +125 °C
Final Electrical Test	Method 5005 (Group A)	+25 °C	-45, +25, +100 °C	-55, +25, +125 °C
Mechanical Seal, Thermal, and Coating Process		Full QorSeal	Full QorSeal	Full QorSeal
External Visual	2009	*	Yes	Yes
Construction Process		QorSeal	QorSeal	QorSeal

\* Per IPC-A-610 Class 3

MilQor converters and filters are offered in three variations of environmental stress screening options. All MilQor converters use SynQor's proprietary QorSeal™ Hi-Rel assembly process that includes a Parylene-C coating of the circuit, a high performance thermal compound filler, and a nickel barrier gold plated aluminum case. Each successively higher grade has more stringent mechanical and electrical testing, as well as a longer burn-in cycle. The ES- and HB-Grades are also constructed of components that have been procured through an element evaluation process that pre-qualifies each new batch of devices.



**MQME-270L-R**  
**Current: 3A**

# Technical Specification

## MilQor Filter Family Matrix

The tables below show the array of MilQor filters available. When ordering SynQor converters, please ensure that you use the complete part number according to the table in the last page. Contact the factory for other requirements.

Product Family Designator	Continuous Input Voltage	Power (Amperage) Rating	Version (see table below)	Features Available (In Addition to Passive Filter Components)			
				Enable Pass-Through Circuitry	Transient Suppression Circuitry	Soft-Start Circuitry	Reverse Polarity Protection Circuitry
MQME-28	40V	320W (20A)	P				
MQME-28E	70V		T	•	•	•	•
			T6	•	•	•	•
MQHE-28	40V	160W (10A)	P				
MQHE-28E	70V						
MQHE-270	400V	160W (1A)	P				
MQME-270	400V	320W (2A)	P				
			R				•
MQME-270L	400V	200W (3A)	P				
			R				•



**MQME-270L-R**  
**Current: 3A**

# Technical Specification

## PART NUMBERING SYSTEM

The part numbering system for SynQor's *MilQor* DC-DC converters follows the format shown in the table below.

Model Name	Input Voltage Range	Version	Package Outline/Pin Configuration	Screening Grade
MQME MQHE	28 28E	P T T6	U X Y W Z	C ES HB
	270 270L	P R		

Not all combinations make valid part numbers, please contact SynQor for availability. See the Product Summary web page for more options.

**Example: MQME-270L-R-Y-ES**

## APPLICATION NOTES

A variety of application notes and technical white papers can be downloaded in pdf format from the SynQor website.

## PATENTS

SynQor holds the following U.S. patents, one or more of which apply to each product listed in this document. Additional patent applications may be pending or filed in the future.

5,999,417	6,222,742	6,545,890	6,577,109	6,594,159	6,731,520
6,894,468	6,896,526	6,927,987	7,050,309	7,072,190	7,085,146
7,119,524	7,269,034	7,272,021	7,272,023	7,558,083	7,564,702
7,765,687	7,787,261	8,023,290	8,149,597		

### Contact SynQor for further information and to order:

**Phone:** 978-849-0600  
**Toll Free:** 888-567-9596  
**Fax:** 978-849-0602  
**E-mail:** [mqnbofae@synqor.com](mailto:mqnbofae@synqor.com)  
**Web:** [www.synqor.com](http://www.synqor.com)  
**Address:** 155 Swanson Road  
 Boxborough, MA 01719  
 USA

### Warranty

SynQor offers a two (2) year limited warranty. Complete warranty information is listed on our website or is available upon request from SynQor.

Information furnished by SynQor is believed to be accurate and reliable. However, no responsibility is assumed by SynQor for its use, nor for any infringements of patents or other rights of third parties which may result from its use. No license is granted by implication or otherwise under any patent or patent rights of SynQor.